



GLASS
ATELIER

MASIERO



GLASS
ATELIER

MASIERO



GLASS

L'antica arte vetraia veneziana tramanda la sua eccellenza nota in tutto il mondo.

L'originale tecnica della graniglia regala sorprendente profondità materica al vetro, creando un decoro volutamente mai uguale, che rende ogni pezzo unico.

La tradizione dei lampadari di cristallo di Bohemia disegna grandi cadute in vetro, la cui trasparenza dona effetti luminosi unici.

The ancient art of Venetian glass perpetuates its excellence, famous throughout the world. The original graniglia technique gives the glass surprising depth and substance, with each piece made unique by a purposely ever-different decoration. Unique lighting effects are created by the large glass pendants in the tradition of Bohemia crystal chandeliers.

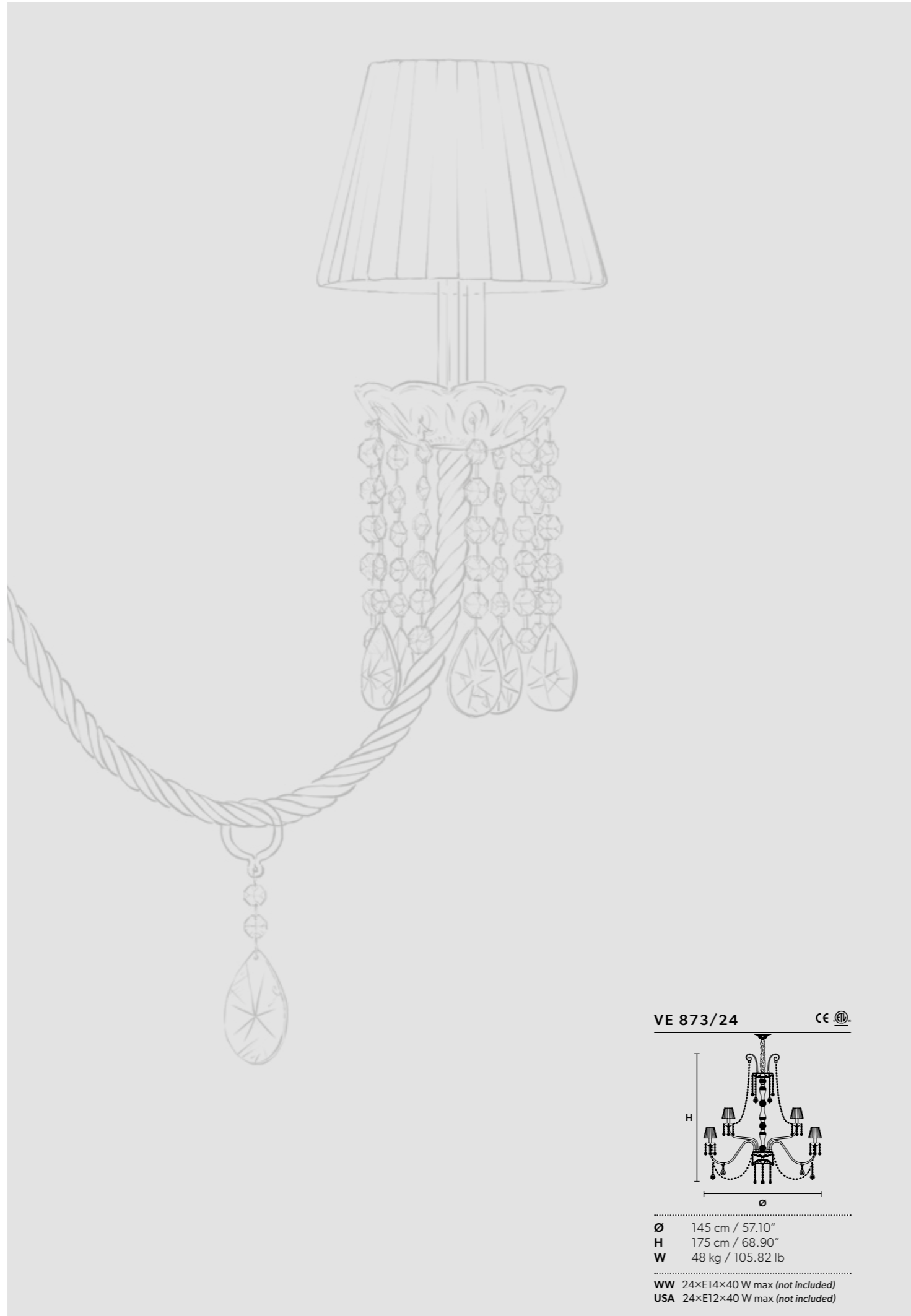



VE 873/A5 CE

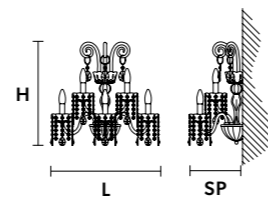

- L 53 cm / 20.90"
- SP 30 cm / 11.80"
- H 50 cm / 19.70"
- W 4.5 kg / 9.92lb

WW 5×E14×40 W max (not included)
 USA 5×E12×40 W max (not included)

VE 873/A5



VE 871/A5



VE 871/A3

VE 871/A3



VE 871/A5



VE 871/A12

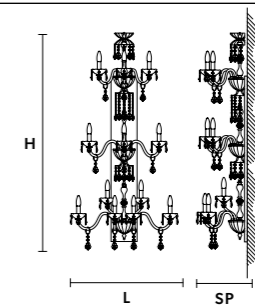
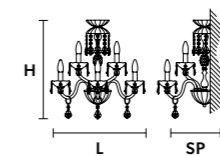
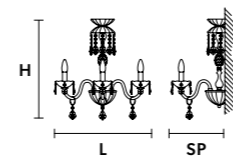

L 50 cm / 19.70"
SP 28 cm / 11.05"
H 54 cm / 21.25"
W 3 kg / 6.61 lb
WW 3×E14×40 W max (not included)
USA 3×E12×40 W max (not included)

L 50 cm / 19.70"
SP 28 cm / 11.05"
H 54 cm / 21.25"
W 4 kg / 8.81 lb
WW 5×E14×40 W max (not included)
USA 5×E12×40 W max (not included)

L 75 cm / 29.60"
SP 30 cm / 11.80"
H 140 cm / 55.20"
W 6 kg / 13.22 lb
WW 12×E14×40 W max (not included)
USA 12×E12×40 W max (not included)



VE 871/32	CE	VE 871/64	CE
Ø 110 cm / 43.30" H 270 cm / 106.30" W 64 kg / 110.23 lb		Ø 140 cm / 55.20" H 500 cm / 196.90" W 100 kg / 220.46 lb	
WW 32×E14×40 W max (not included) USA 32×E12×40 W max (not included)		WW 64×E14×40 W max (not included) USA 64×E12×40 W max (not included)	

VE 871/32



VE 874/16+8 

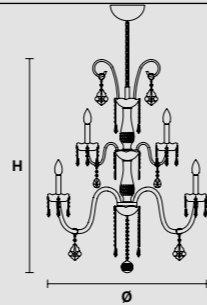

Ø 95 cm / 37.50"
H 110 cm / 43.30"
W 34 kg / 74.95 lb

WW 24×E14×40 W max (not included)
USA 24×E12×40 W max (not included)



VE 874/16+8

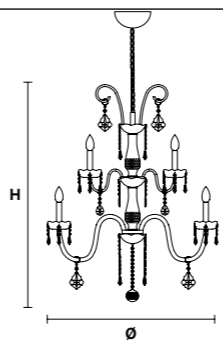
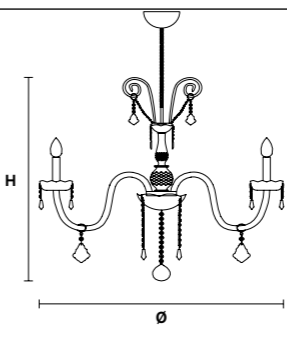

VE 874/5+5	CE	VE 874/12	CE
			
Ø 88 cm / 34.64 "		Ø 103 cm / 40.55 "	
H 112 cm / 44.09 "		H 80 cm / 31.49 "	
W 19 kg / 41.88 lb		W 17 kg / 15.43 lb	
WW 10×E14×40 W max (not included)		WW 12×E14×40 W max (not included)	
USA 10×E12×40 W max (not included)		USA 12×E12×40 W max (not included)	

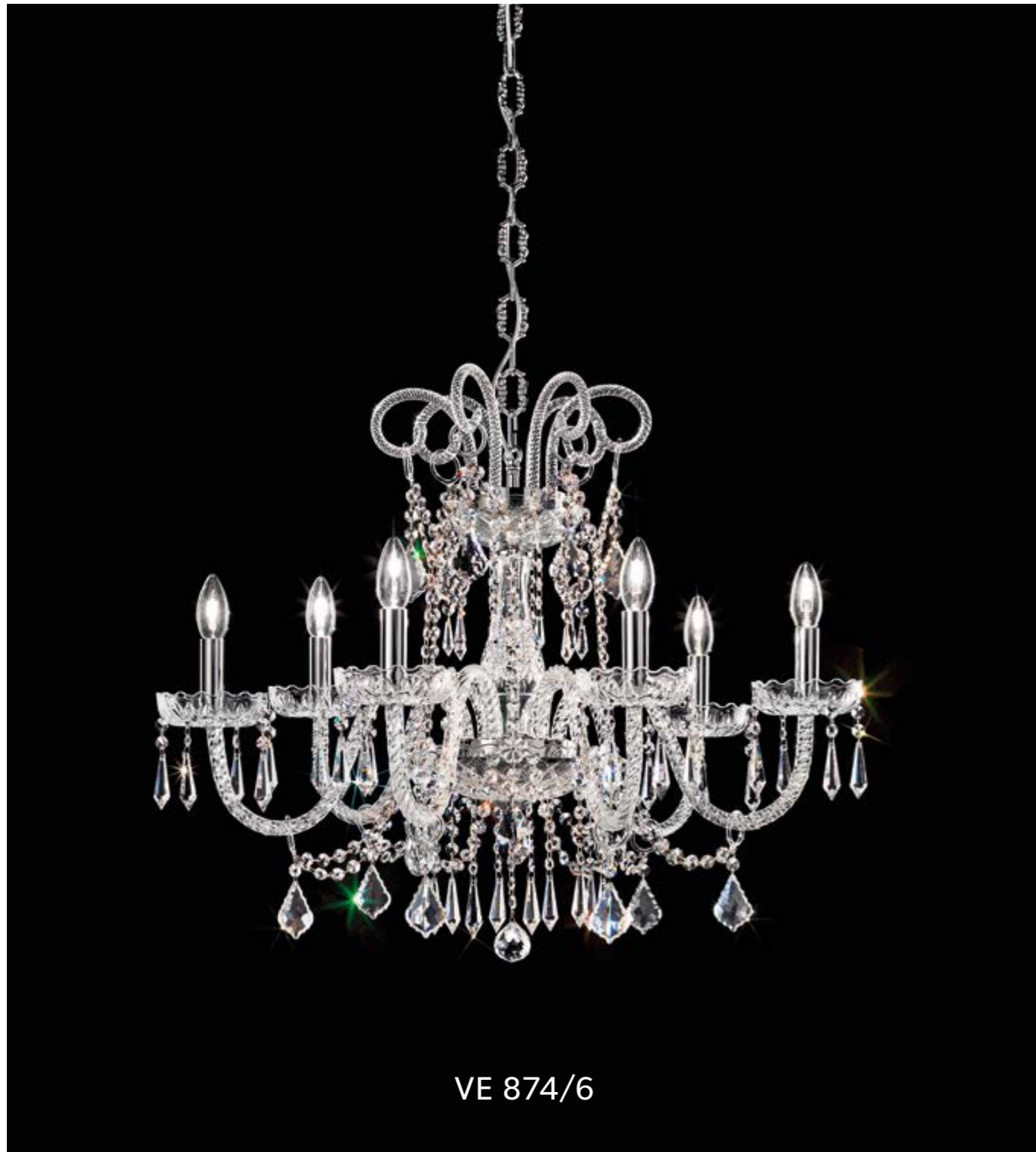

VE 874/6



VE 874/8

VE 874/6	CE	VE 874/8	CE
<p>Ø 77 cm / 30.31"</p> <p>H 63 cm / 24.80"</p> <p>W 9 kg / 19.84 lb</p>		<p>Ø 88 cm / 34.64"</p> <p>H 76 cm / 29.92"</p> <p>W 13 kg / 28.66 lb</p>	
<p>WW 6×E14×40 W max (not included)</p> <p>USA 6×E12×40 W max (not included)</p>		<p>WW 8×E14×40 W max (not included)</p> <p>USA 8×E12×40 W max (not included)</p>	

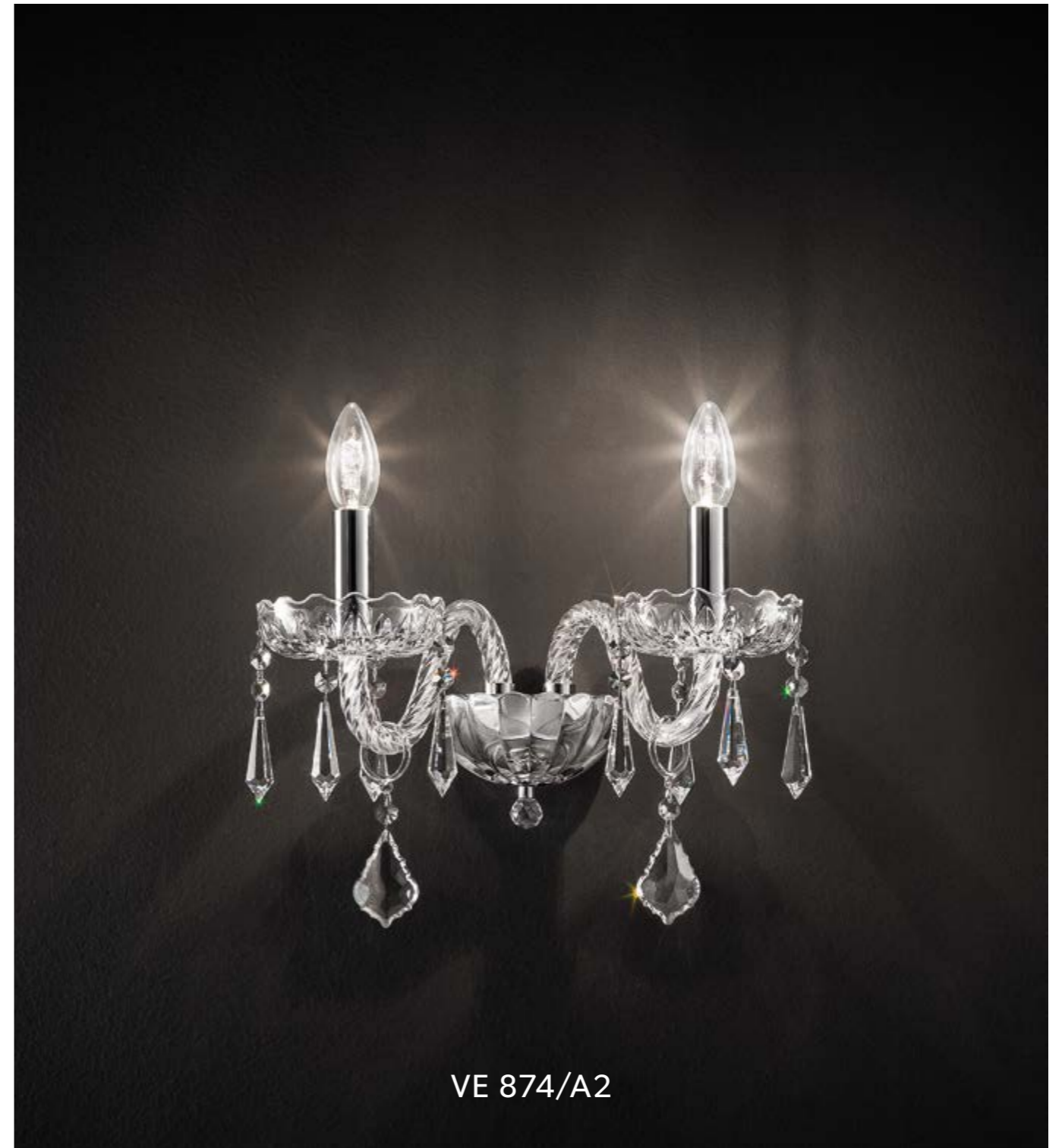

VE 874/A3



VE 874/A2

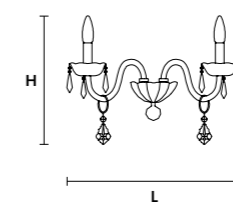
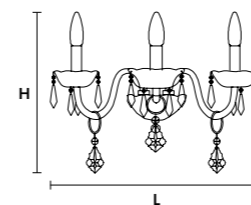

L 44 cm / 17.30"
 SP 26 cm / 10.25"
 H 26 cm / 10.25"
 W 3 kg / 6.61 lb

WW 3x E14x40 W max (not included)
 USA 3x E12x40 W max (not included)

L 35 cm / 13.80"
 SP 22 cm / 8.70"
 H 26 cm / 10.25"
 W 2 kg / 4.41 lb

WW 2x E14x40 W max (not included)
 USA 2x E12x40 W max (not included)



VE 875/12	CE	VE 875/16	CE
<p>Ø 120 cm / 47.30"</p> <p>H 120 cm / 47.30"</p> <p>W 25 kg / 55.11 lb</p>		<p>Ø 145 cm / 57.09"</p> <p>H 120 cm / 47.30"</p> <p>W 32 kg / 70.54 lb</p>	
<p>WW 12×E14×40 W max (not included)</p> <p>USA 12×E12×40 W max (not included)</p>		<p>WW 16×E14×40 W max (not included)</p> <p>USA 16×E12×40 W max (not included)</p>	

VE 875/16

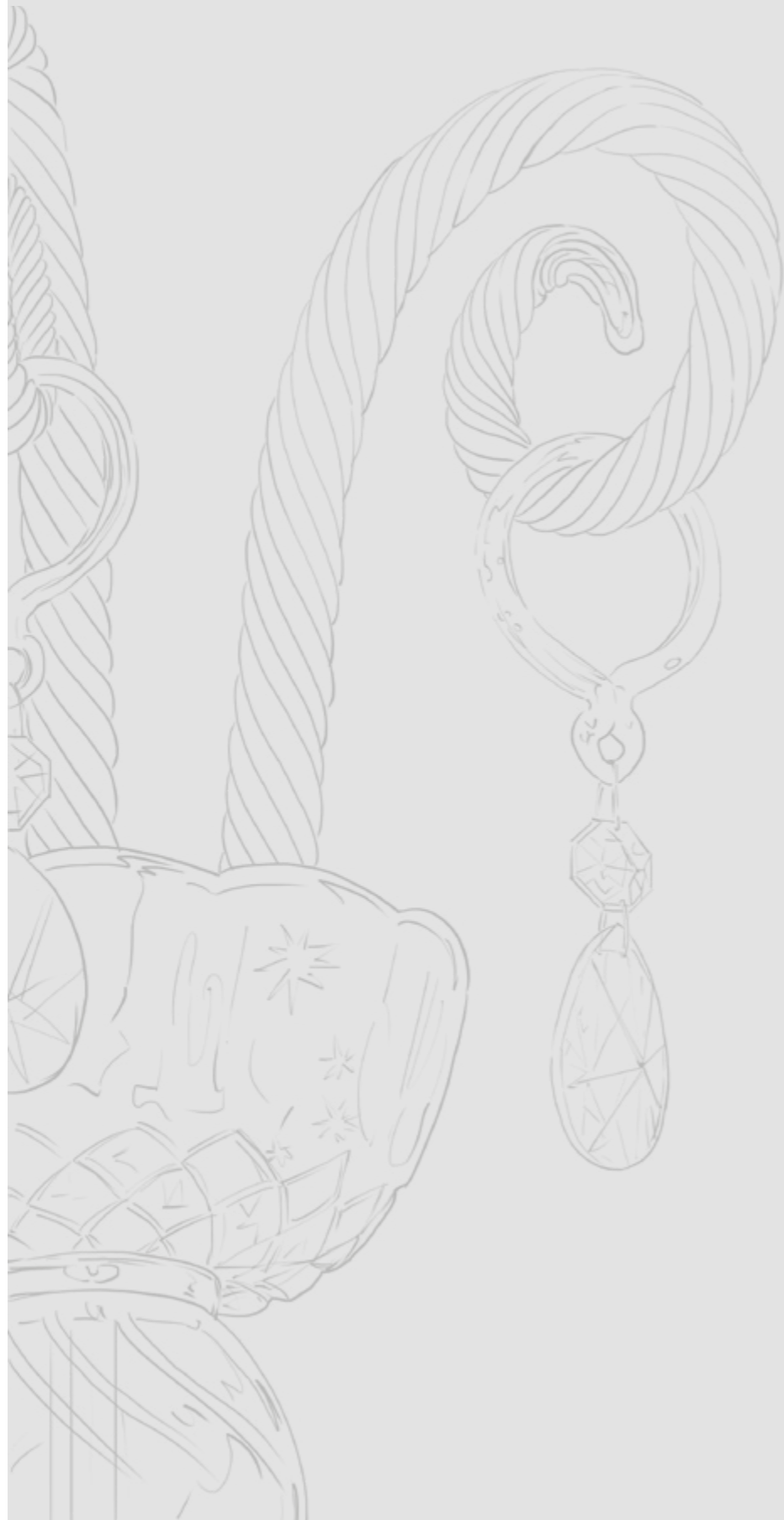

VE 875/A3 CE 

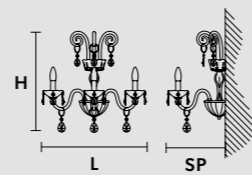

.....
L 48 cm / 18.90"
SP 35 cm / 13.78"
H 50 cm / 19.69"
W 3 kg / 6.61 lb

WW 3×E14×40 W max (not included)
USA 3×E12×40 W max (not included)



VE 875/A3



VE 886/12 

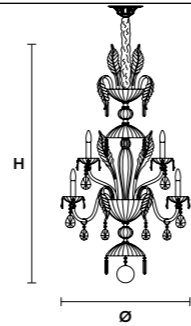

Ø 70 cm / 27.55"
 H 130 cm / 51.20"
 W 27 kg / 59.52 lb
 WW 12×E14×40 W max (not included)
 USA 12×E12×40 W max (not included)

VE 886/12



VE 886/A5

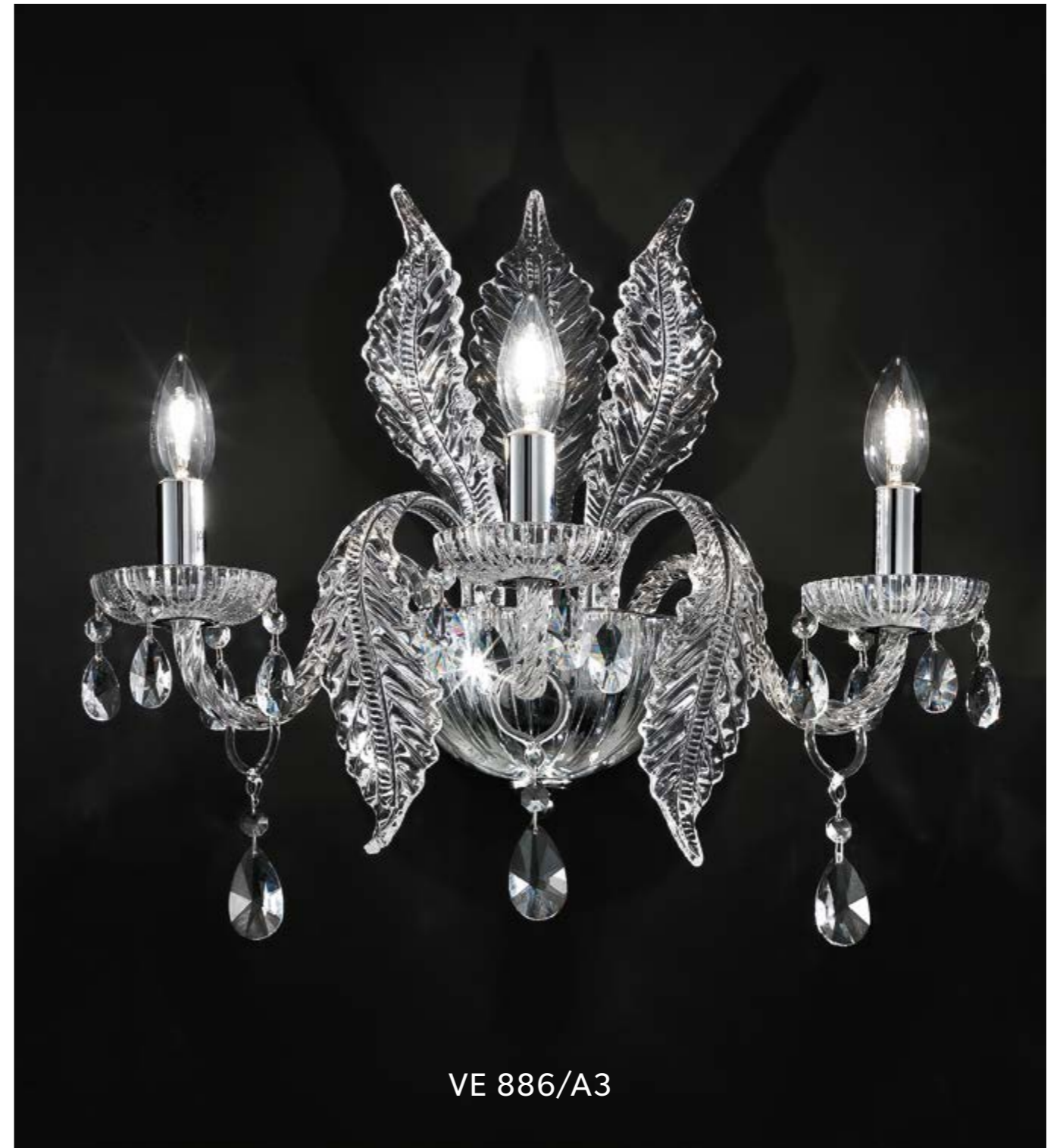

VE 886/A3

VE 886/A5



VE 886/A3

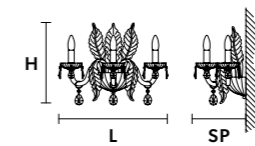
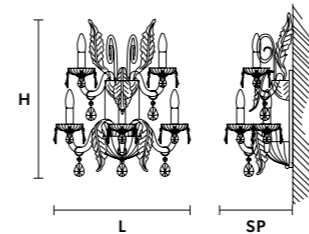

L 50 cm / 19.68"
 SP 30 cm / 11.81"
 H 60 cm / 23.62"
 W 7 kg / 15.43 lb

WW 5x E14x40 W max (not included)
 USA 5x E12x40 W max (not included)

L 48 cm / 18.90"
 SP 28 cm / 11.05"
 H 40 cm / 15.75"
 W 4 kg / 8.81 lb

WW 3x E14x40 W max (not included)
 USA 3x E12x40 W max (not included)



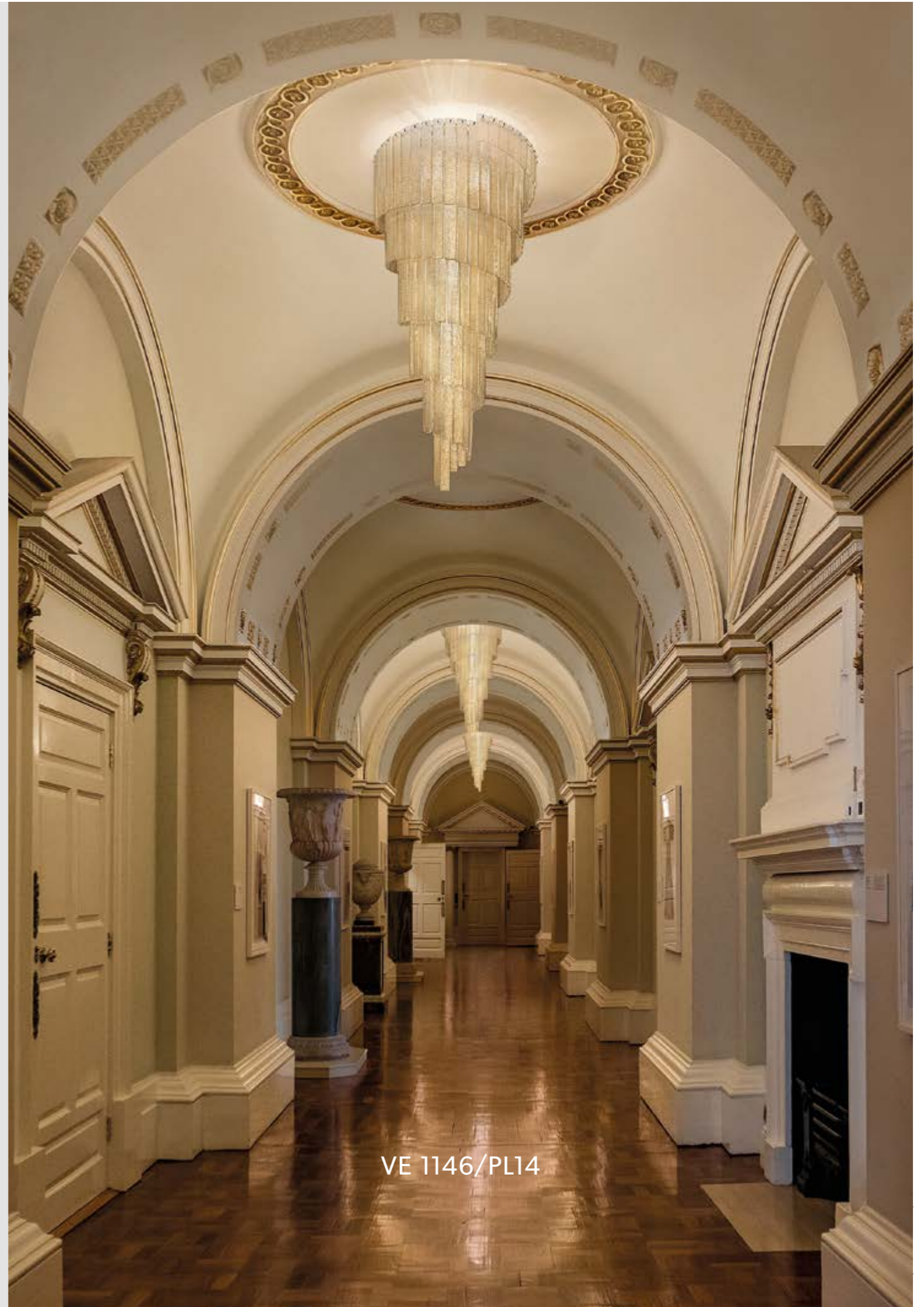
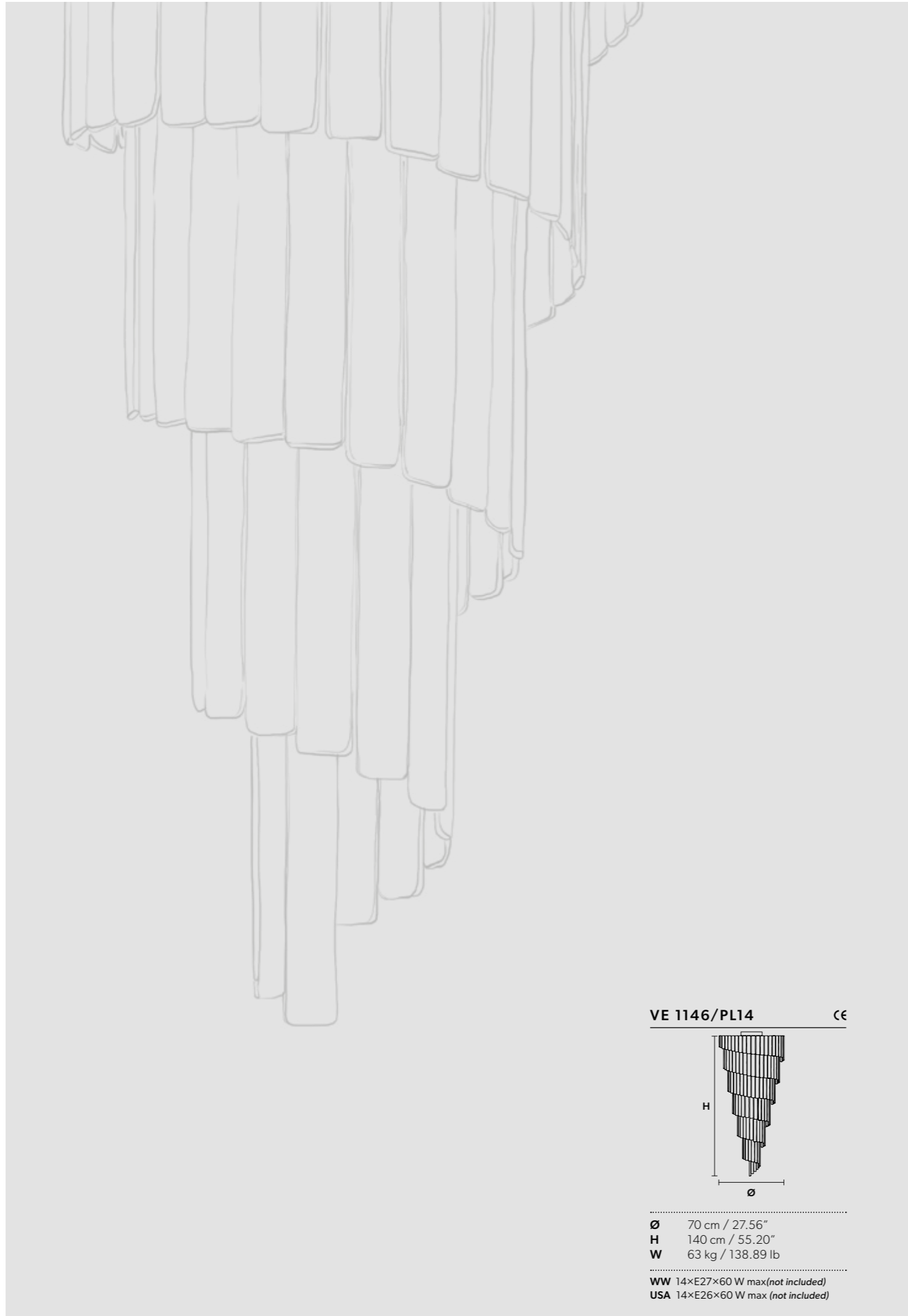



VE 1146/A4

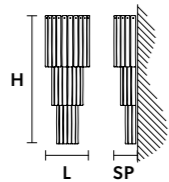
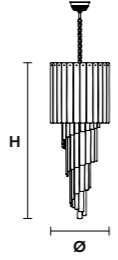
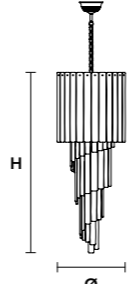

VE 1149/S7

VE 1146/A4	CE	VE 1149/S7	CE	VE 1149/S16	CE
					
L 26 cm / 10.25"		Ø 40 cm / 15.75"		Ø 50 cm / 19.70"	
SP 14 cm / 5.55"		H 90 cm / 35.50"		H 160 cm / 63.00"	
H 70 cm / 27.56"		W 28 kg / 61.72 lb		W 35 kg / 77.16 lb	
W 12 kg / 26.45 lb					
WW 4×E14×40 W max (not included)		WW 7×E14×40 W max (not included)		WW 16×E14×40 W max (not included)	
USA 4×E12×40 W max (not included)		USA 7×E12×40 W max (not included)		USA 16×E12×40 W max (not included)	



VE 1144/S20 VE 1144/S30 VE 1144/S40 VE 1144/S52

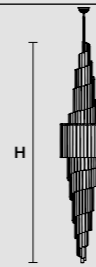
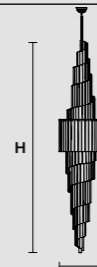
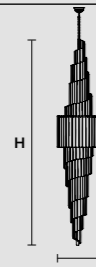
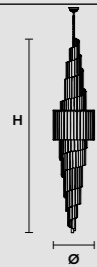

Ø 50 cm / 19.70"
H 230 cm / 90.55"
W 105 kg / 231 lb

Ø 80 cm / 31.50"
H 360 cm / 141.73"
W 240 kg / 529.1 lb

Ø 100 cm / 39.40"
H 450 cm / 177.20"
W 360 kg / 793.6 lb

Ø 120 cm / 47.30"
H 500 cm / 196.90"
W 580 kg / 1278 lb

WW 1xE14x40 W max +
19xE27x60 W max (not included)
USA 1xE12x40 W max +
19xE26x60 W max (not included)



WW 30xE27x60 W max (not included)
USA 30xE26x60 W max (not included)

WW 40xE27x60 W max (not included)
USA 40xE26x60 W max (not included)

WW 52xE27x60 W max (not included)
USA 52xE26x60 W max (not included)

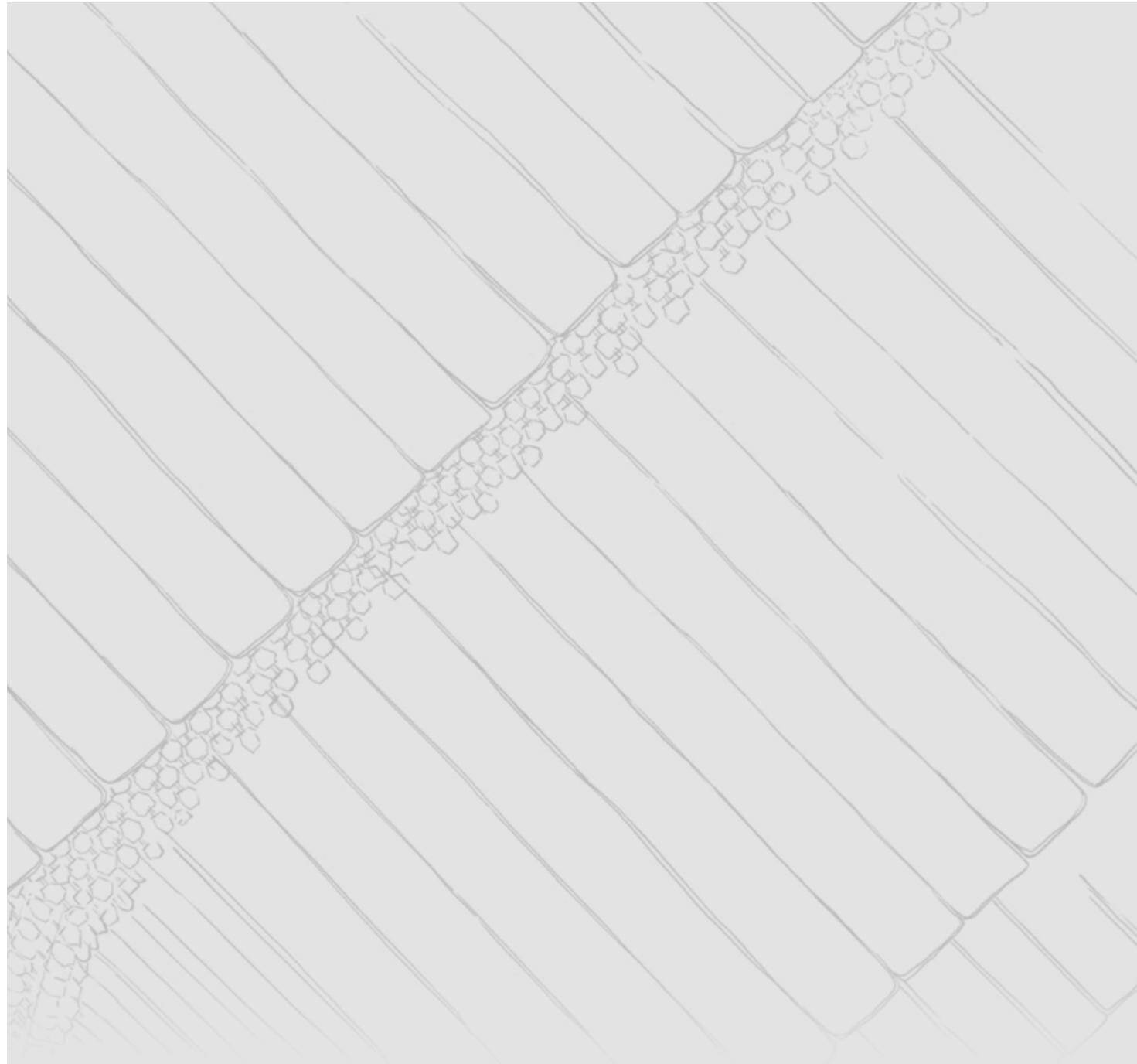
VE 1144/S20

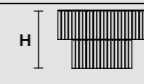

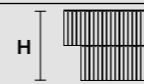
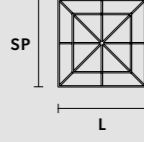
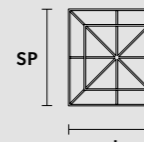
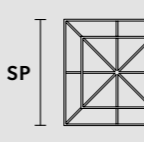
VE 1120/PL12	CE	VE 1120/PL14	CE	VE 1120/PL16	CE
					
					
L 80 cm / 31.50"		L 100 cm / 39.40"		L 120 cm / 47.30"	
SP 80 cm / 31.50"		SP 100 cm / 39.40"		SP 120 cm / 47.30"	
H 80 cm / 31.50"		H 80 cm / 31.50"		H 80 cm / 31.50"	
W 45 kg / 99.20 lb		W 55 kg / 121.25 lb		W 71 kg / 156.52 lb	
WW 12×E27×60 W max (not included)		WW 14×E27×60 W max (not included)		WW 16×E27×60 W max (not included)	
USA 12×E26×60 W max (not included)		USA 14×E26×60 W max (not included)		USA 16×E26×60 W max (not included)	

VE 1120/PL16

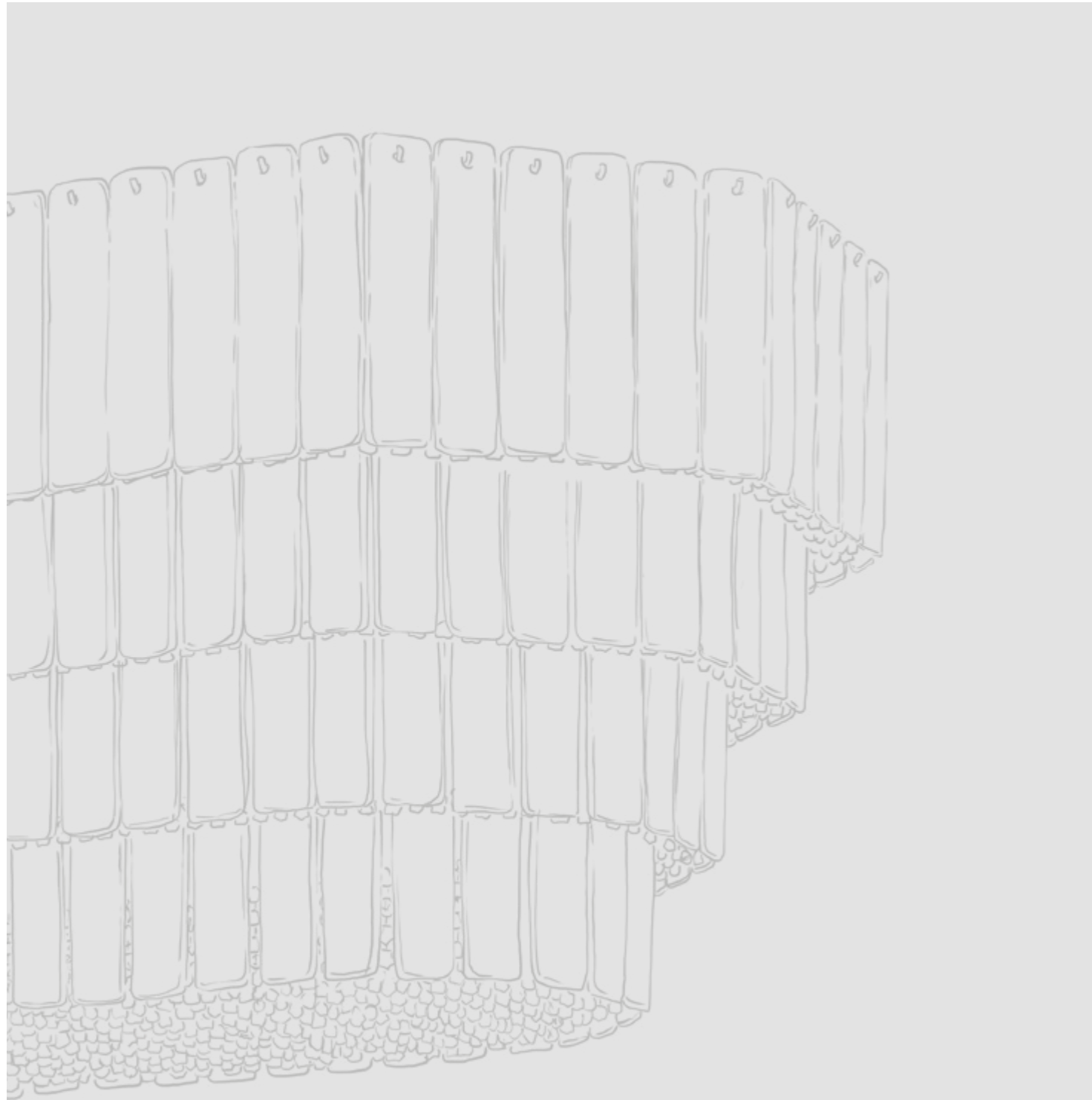

VE 1147/PL16 €

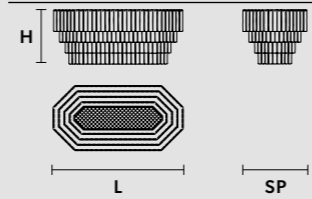

-
- L** 120 cm / 47.30"
- SP** 60 cm / 23.70"
- H** 50 cm / 19.70"
- W** 80 kg / 176.36 lb
-
- WW** 16×E14×40 W max (not included)
- USA** 16×E12×40 W max (not included)

VE 1147/PL16



VE 1120/28 

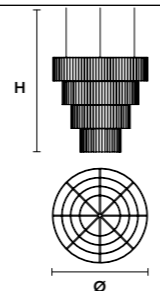

Ø 170 cm / 67.00"
 H 150 cm / 59.10"
 W 263 kg / 579.8 lb
 WW 28×E27×60 W max (not included)
 USA 28×E26×60 W max (not included)



VE 1120/28

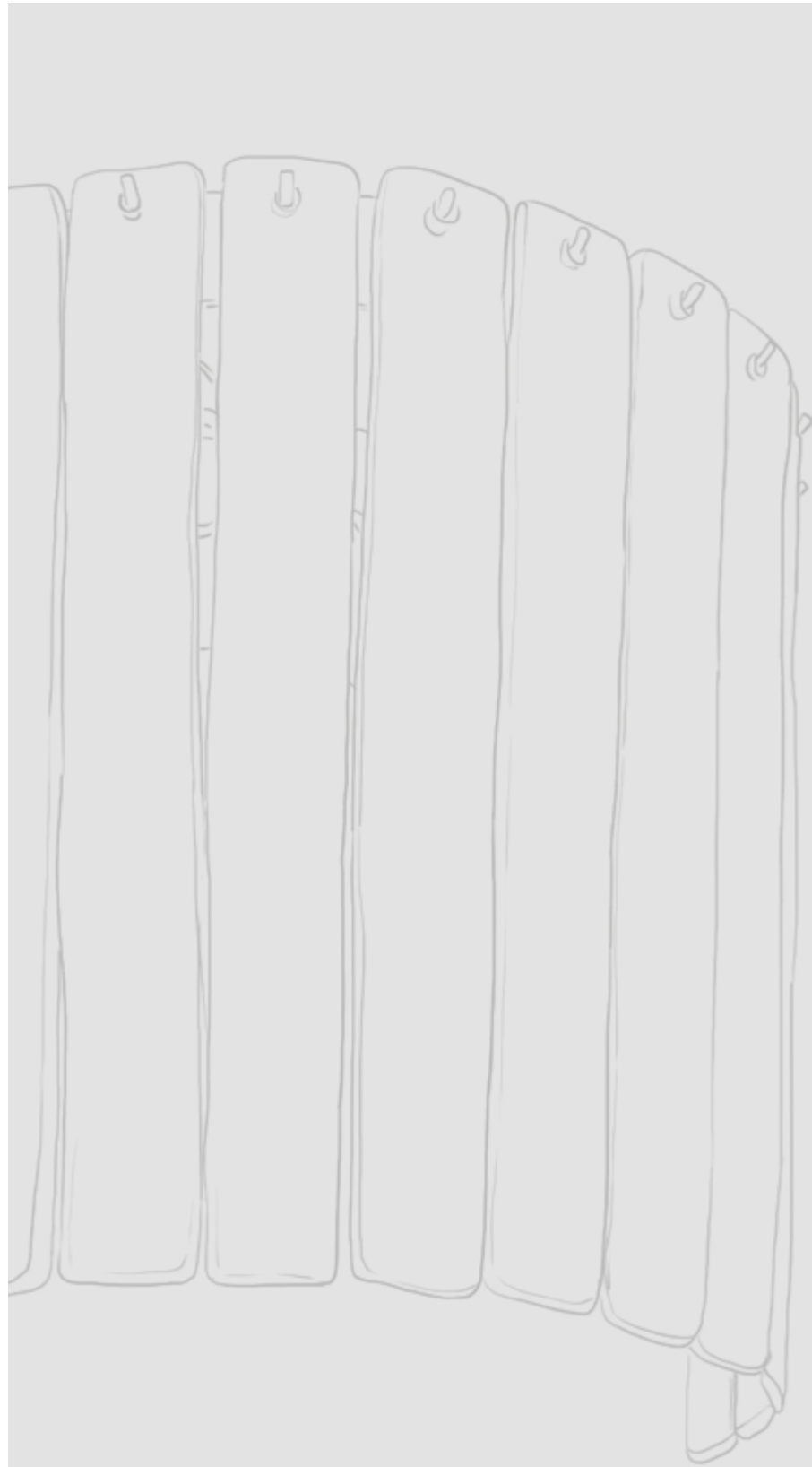

VE 1120/A2 CE 

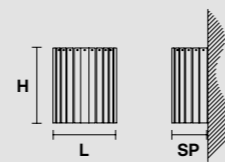

.....
L 38 cm / 15.00"
SP 20 cm / 7.90"
H 40 cm / 15.75"
W 8 kg / 17.63 lb

WW 2xE27x60 W max (not included)
USA 2xE26x60 W max (not included)



VE 1120/A2

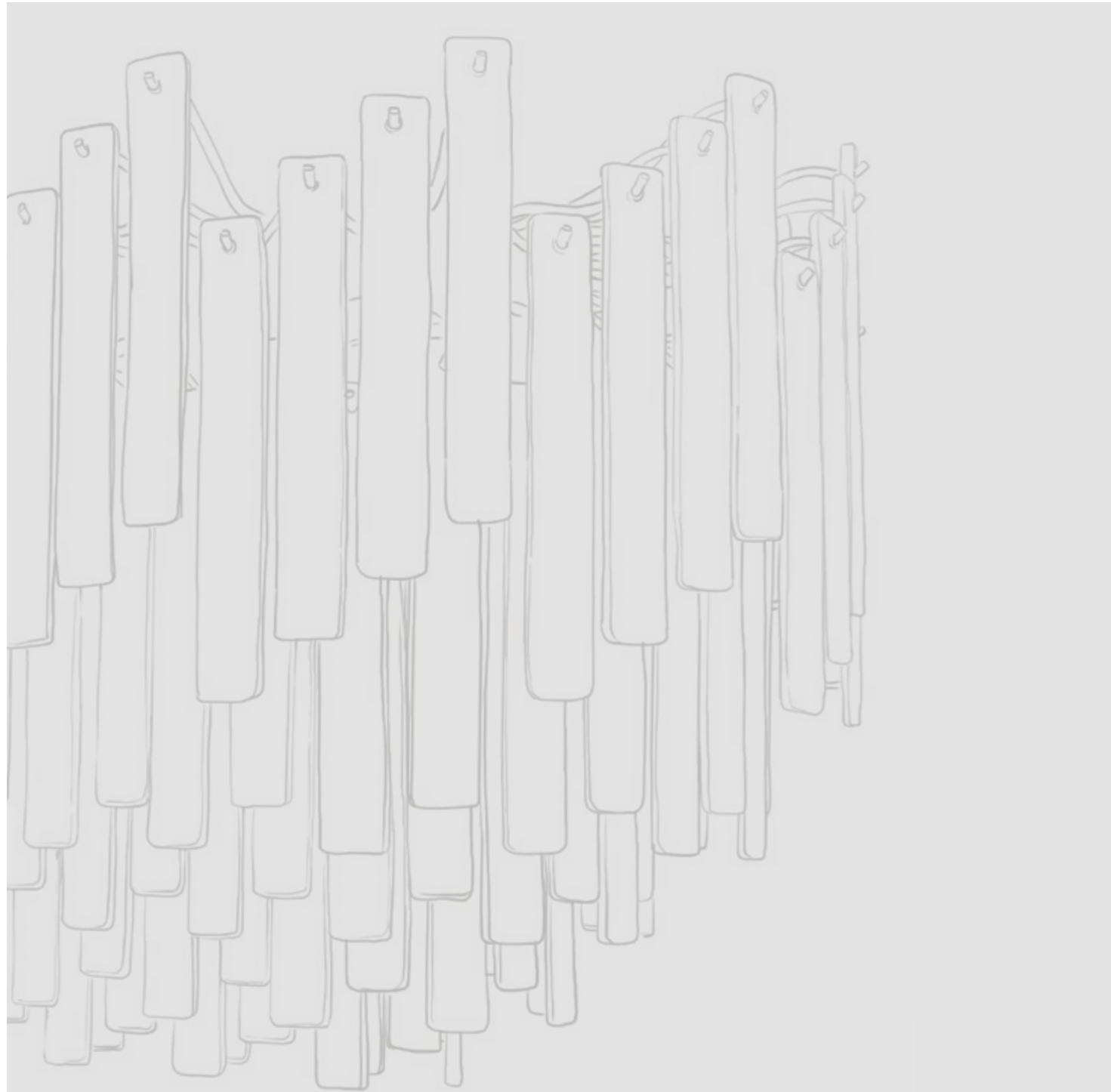

VE 1145/S8 OV 

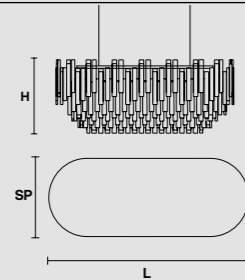

L 85 cm / 33.46"
 SP 52 cm / 20.50"
 H 50 cm / 19.70"
 W 50 kg / 110.23 lb
 WW 8×E27×60 W max (not included)
 USA 8×E26×60 W max (not included)

VE 1145/S14 OV 

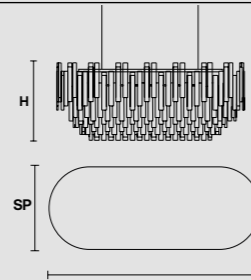

L 120 cm / 47.24"
 SP 52 cm / 20.50"
 H 50 cm / 19.70"
 W 68 kg / 149.91 lb
 WW 14×E27×60 W max (not included)
 USA 14×E26×60 W max (not included)

VE 1145/S20 OV 

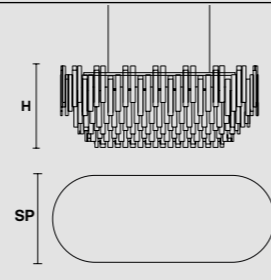

L 155 cm / 61.00"
 SP 52 cm / 20.50"
 H 50 cm / 19.70"
 W 95 kg / 209.44 lb
 WW 20×E27×60 W max (not included)
 USA 20×E26×60 W max (not included)

VE 1145/S14 OV

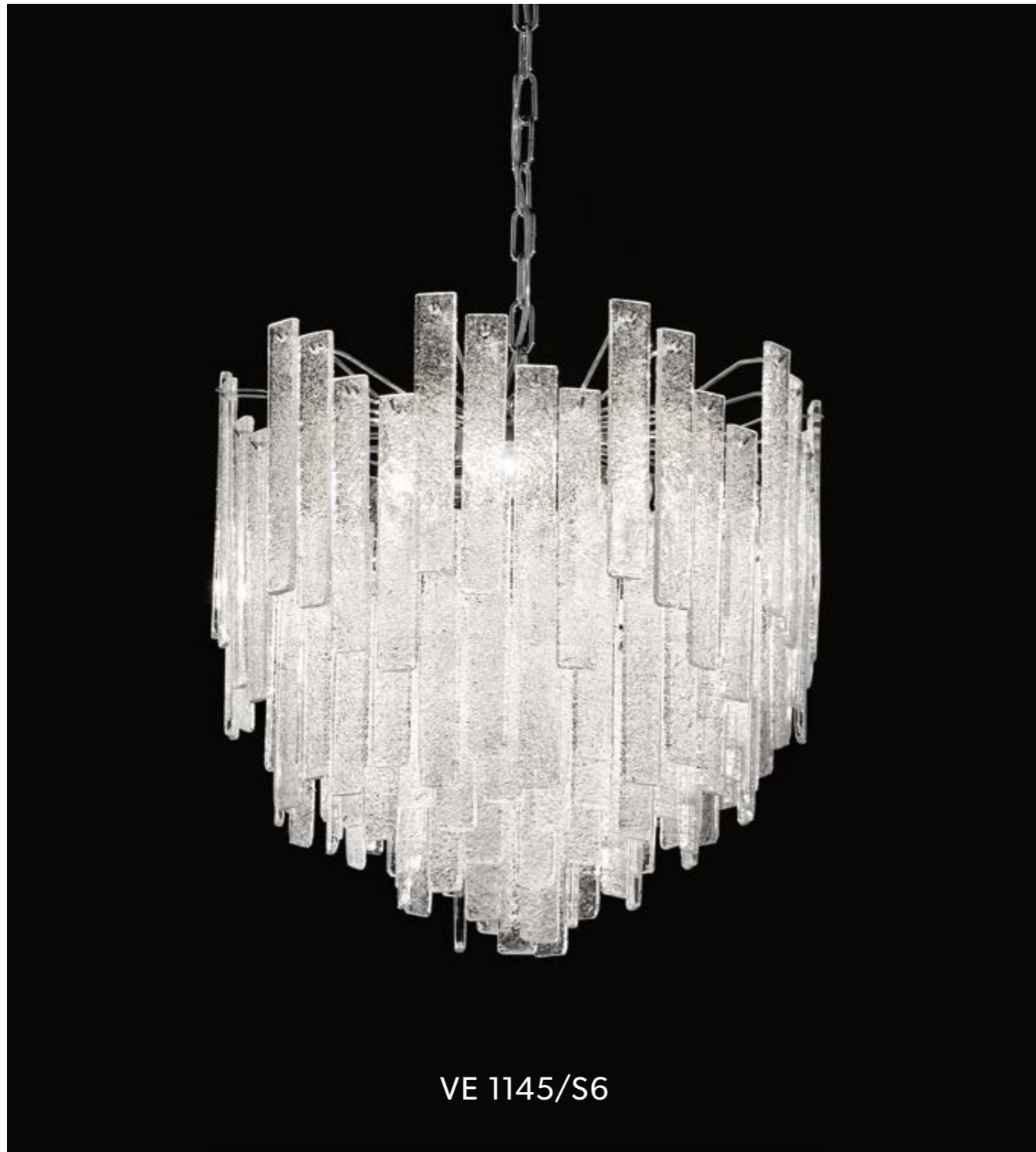

VE 1145/S6

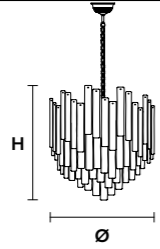
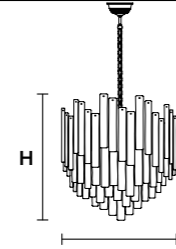
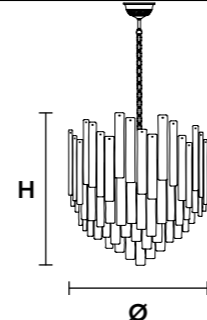

VE 1145/S14

VE 1145/S6	VE 1145/S14	VE 1145/S20
		
<p>Ø 52 cm / 20.47"</p> <p>H 50 cm / 19.69"</p> <p>W 29 kg / 63.93 lb</p> <p>WW 6×E27×60 W max (not included)</p> <p>USA 6×E26×60 W max (not included)</p>	<p>Ø 80 cm / 31.50"</p> <p>H 75 cm / 29.53"</p> <p>W 65 kg / 143.3 lb</p> <p>WW 14×E27×60 W max (not included)</p> <p>USA 14×E26×60 W max (not included)</p>	<p>Ø 100 cm / 39.37"</p> <p>H 110 cm / 43.31"</p> <p>W 100 kg / 220.4 lb</p> <p>WW 20×E27×60 W max (not included)</p> <p>USA 20×E26×60 W max (not included)</p>





VE 1110/PL5+3+2

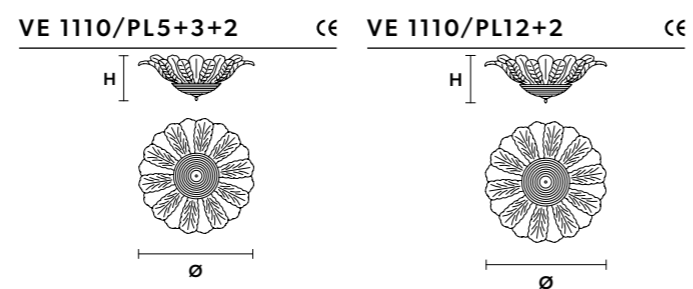

Ø 100 cm / 39.37"
H 60 cm / 23.62"
W 33 kg / 72.75 lb

WW 10×E27×60 W max (not included)
USA 10×E26×60 W max(not included)

Ø 140 cm / 55.12"
H 85 cm / 33.46"
W 47 kg / 103.61 lb

WW 14×E27×60 W max (not included)
USA 14×E26×60 W max (not included)



VE 1110/PL12+2



VE 1112/PL6+3+3



VE 1112/A1+1

VE 1112/PL6+3+3

CE VE 1112/A1+1

CE

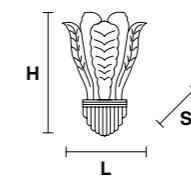
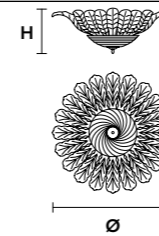

Ø 110 cm / 43.30"
H 70 cm / 27.56"
W 40 kg / 88.18 lb

L 40 cm / 21.65"
SP 20 cm / 7.87"
H 55 cm / 21.65"
W 12.5 kg / 27.55 lb

WW 12×E27×60 W max (not included)
USA 12×E26×60 W max (not included)

WW 1×E27×60 W max +
1×E14×40 W max (not included)
USA 1×E26×60 W max +
1×E12×40 W max (not included)



VE 1114/PL3 AMB

VE 1115/PL5 AMB

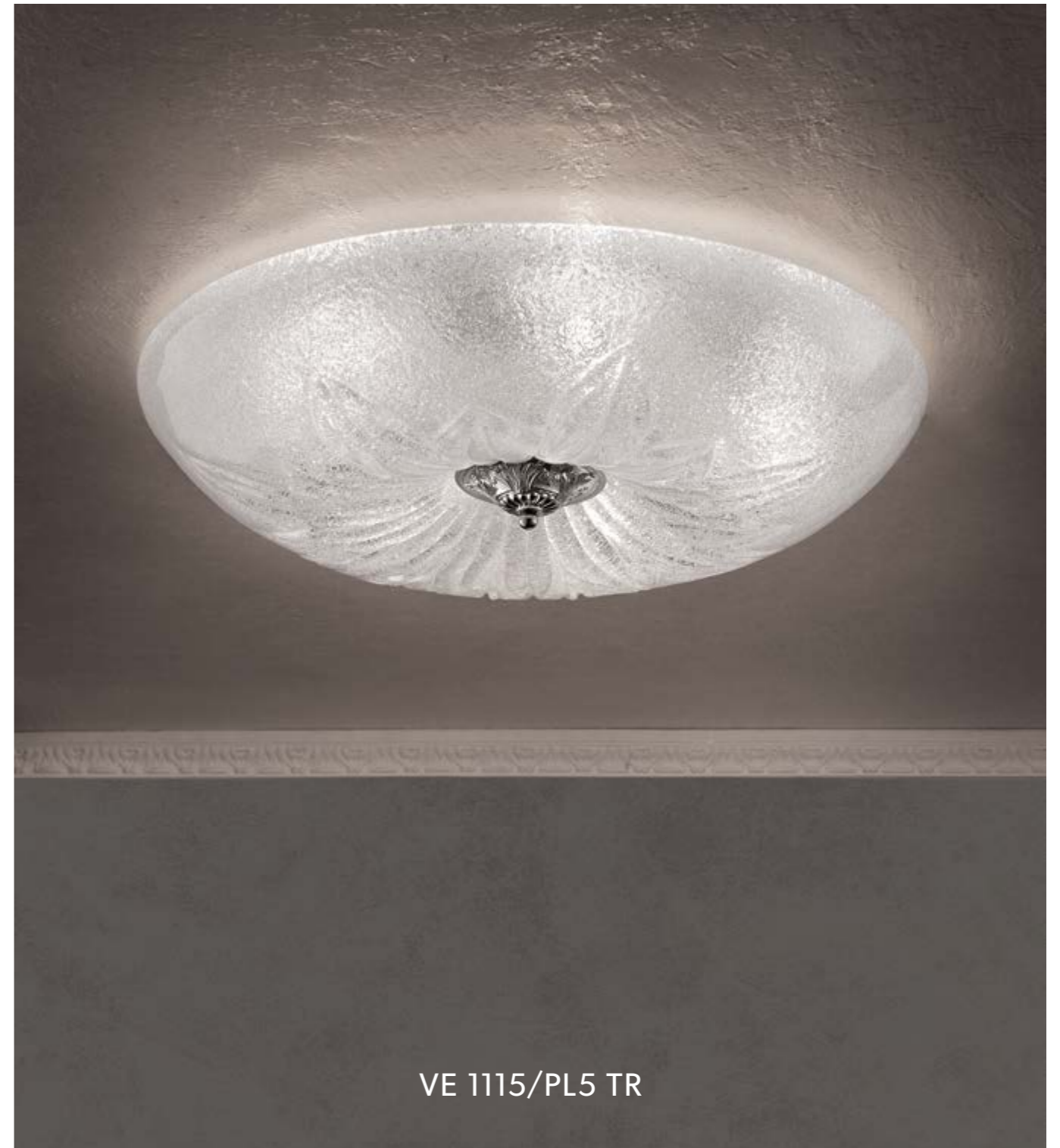

VE 1115/PL5 TR

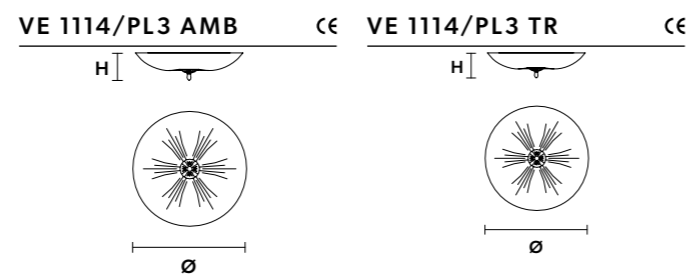

Ø 45 cm / 17.80"
H 12 cm / 4.80"
W 8.5 kg / 18.73 lb
WW 3×E27×60 W max (not included)
USA 3×E26×60 W max (not included)

Ø 45 cm / 17.80"
H 12 cm / 4.80"
W 8.5 kg / 18.73 lb
WW 3×E27×60 W max (not included)
USA 3×E26×60 W max (not included)

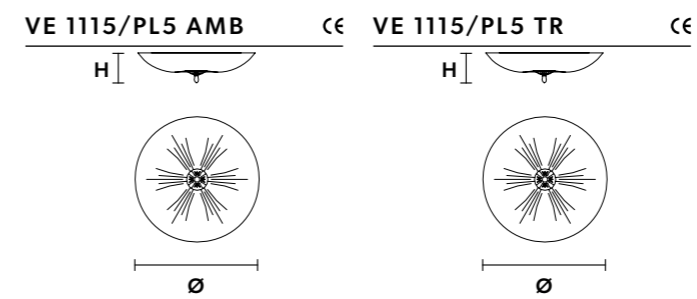

Ø 65 cm / 25.60"
H 15 cm / 6.00"
W 14 kg / 30.86 lb
WW 5×E27×60 W max (not included)
USA 5×E26×60 W max (not included)

Ø 65 cm / 25.60"
H 15 cm / 6.00"
W 14 kg / 30.86 lb
WW 5×E27×60 W max (not included)
USA 5×E26×60 W max (not included)

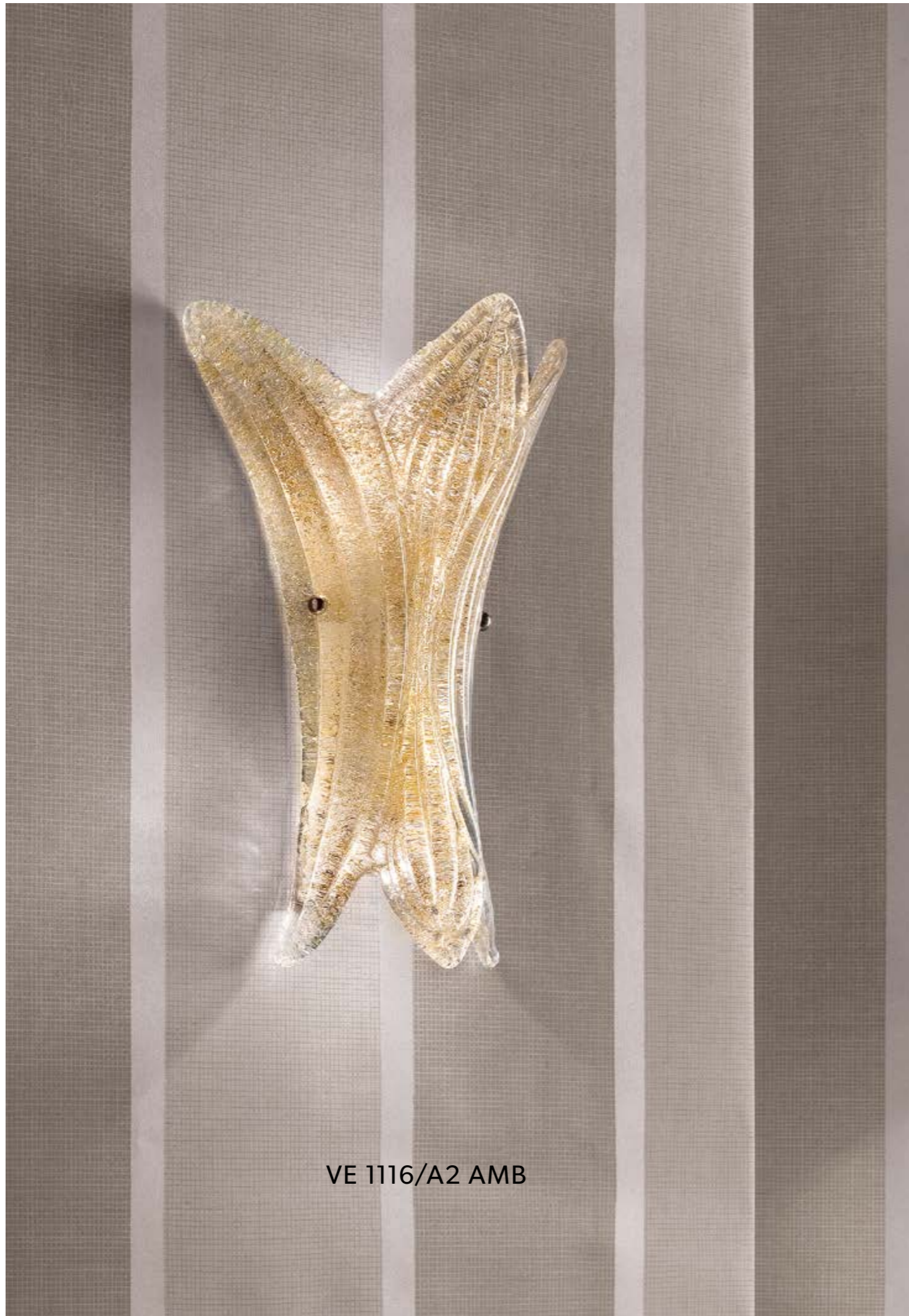

VE 1116/A2 AMB

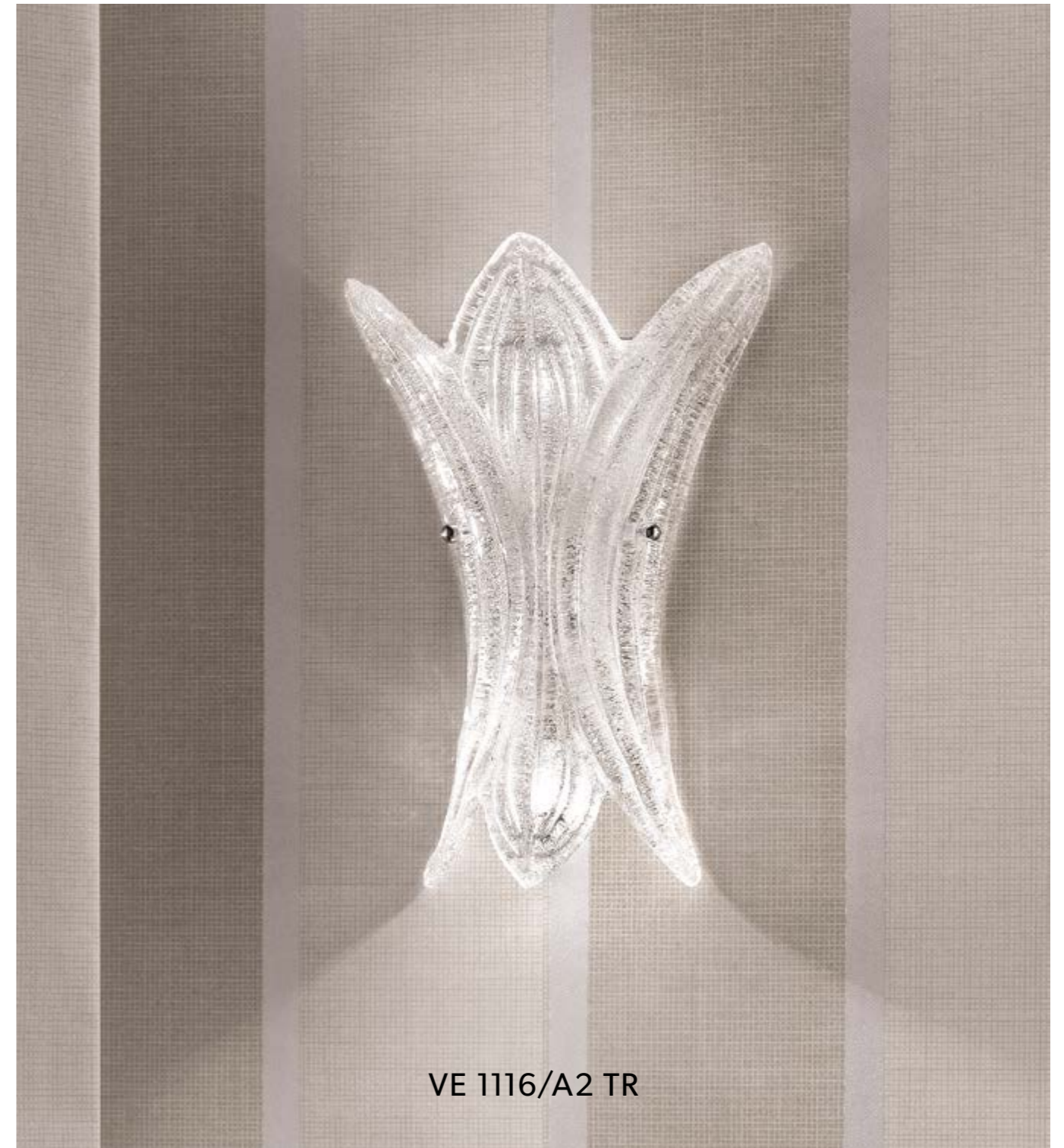

VE 1116/A2 TR

VE 1116/A2 AMB



VE 1116/A2 TR

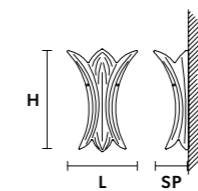
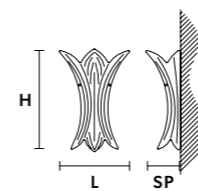

L 28 cm / 11.10"
 SP 15 cm / 6.00"
 H 38 cm / 15.00"
 W 3 kg / 6.61 lb

L 28 cm / 11.10"
 SP 15 cm / 6.00"
 H 38 cm / 15.00"
 W 3 kg / 6.61 lb

WW 2x E14 x 40 W max (not included)
 USA 2x E12 x 40 W max (not included)

WW 2x E14 x 40 W max (not included)
 USA 2x E12 x 40 W max (not included)

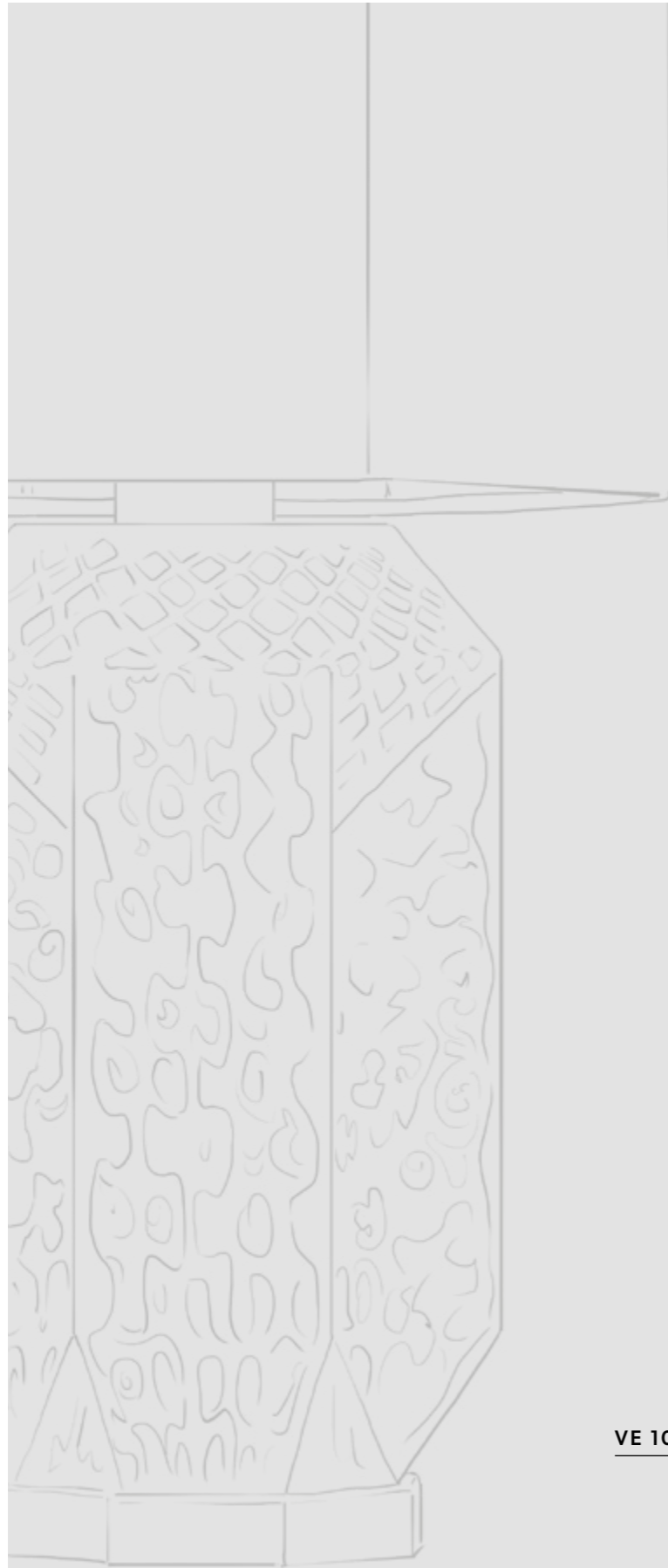

VE 1057/TL1



VE 1058/TL1

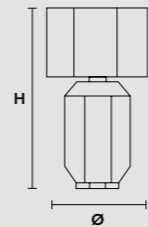
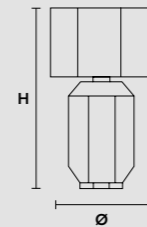

Ø 29 cm / 11.40"
H 49 cm / 19.30"
W 3 kg / 6.61 lb

WW 1×E27×60 W max (not included)
USA 1×E26×60 W max (not included)

Ø 29 cm / 11.40"
H 49 cm / 19.30"
W 3 kg / 6.61 lb

WW 1×E27×60 W max (not included)
USA 1×E26×60 W max (not included)



VE 1057/TL1

VE 1058/TL1



VE 1056/TL1 BLU

VE 1056/TL1 YEL



VE 1055/TL1

VE 1056/TL1 BLU * VE 1056/TL1 YEL * VE 1055/TL1 *

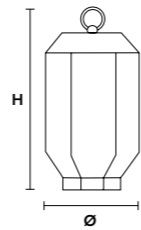
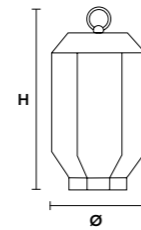
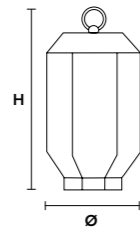

Ø 18 cm / 7.00"
H 35 cm / 13.80"

Ø 18 cm / 7.00"
H 35 cm / 13.80"

Ø 18 cm / 7.00"
H 35 cm / 13.80"

WW 1×E14×40 W max (not included)
USA 1×E12×40 W max (not included)

WW 1×E14×40 W max (not included)
USA 1×E12×40 W max (not included)

WW 1×E14×40 W max (not included)
USA 1×E12×40 W max (not included)

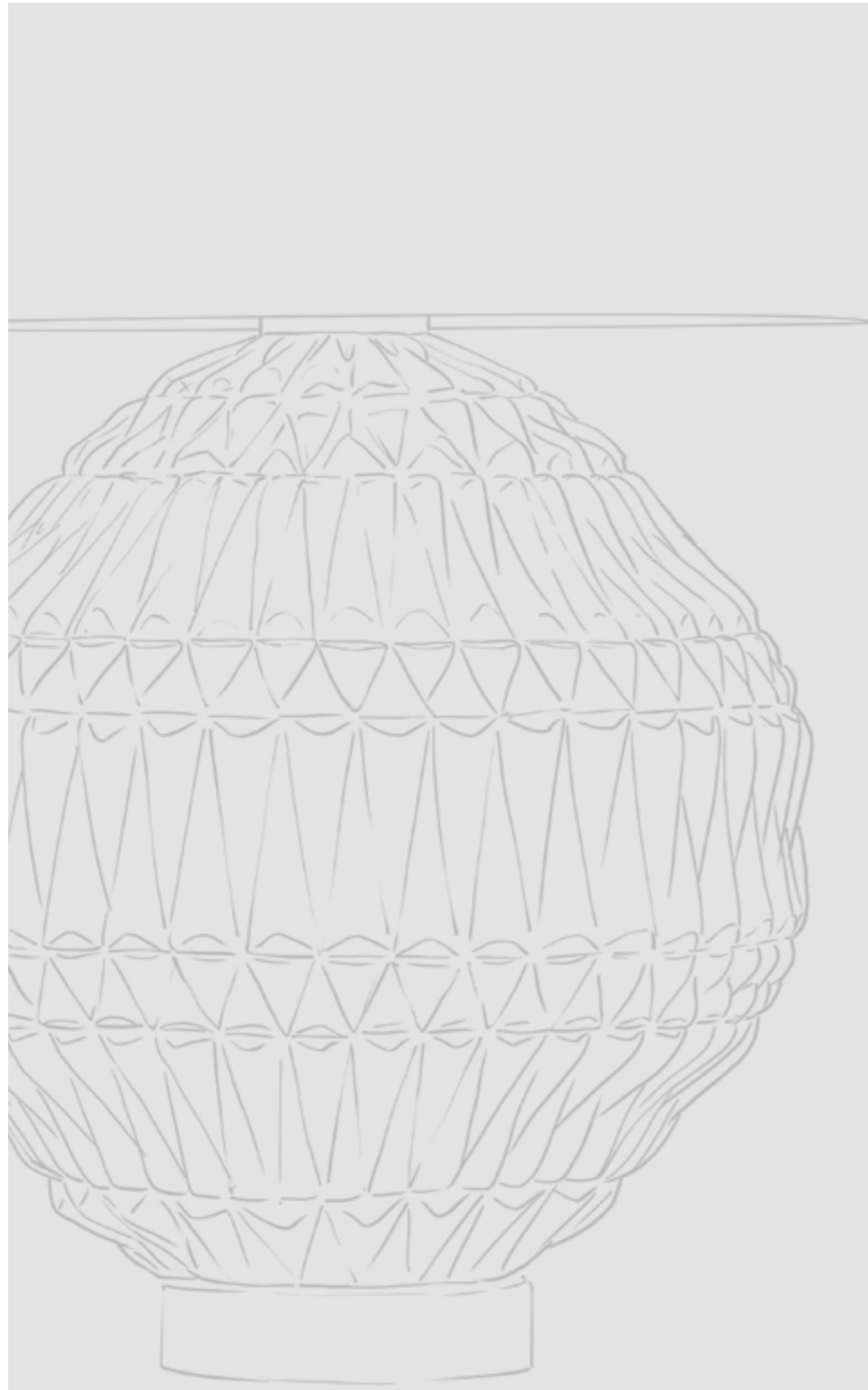

VE 1052/TL1 P * VE 1052/TL1 G * VE 1053/TL1 P * VE 1053/TL1 G *

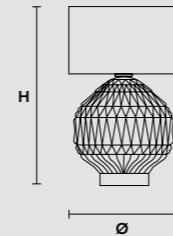
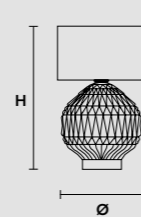
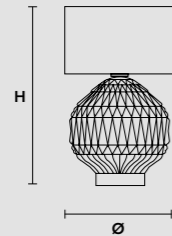
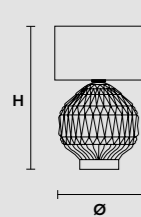

Ø 25 cm / 9.80"
H 38 cm / 15.00"
W 1.6 kg / 3.53 lb

Ø 32 cm / 12.59"
H 50 cm / 19.68"
W 2.6 kg / 5.73 lb

Ø 25 cm / 9.80"
H 38 cm / 15.00"
W 1.6 kg / 3.53 lb

Ø 32 cm / 12.59"
H 50 cm / 19.68"
W 2.6 kg / 5.73 lb

WW 1×E14×40 W max (not included)
USA 1×E12×40 W max (not included)

WW 1×E27×60 W max (not included)
USA 1×E26×60 W max (not included)

WW 1×E14×40 W max (not included)
USA 1×E12×40 W max (not included)

WW 1×E27×60 W max (not included)
USA 1×E26×60 W max (not included)



VE 1052/TL1 G

VE 1053/TL1 P

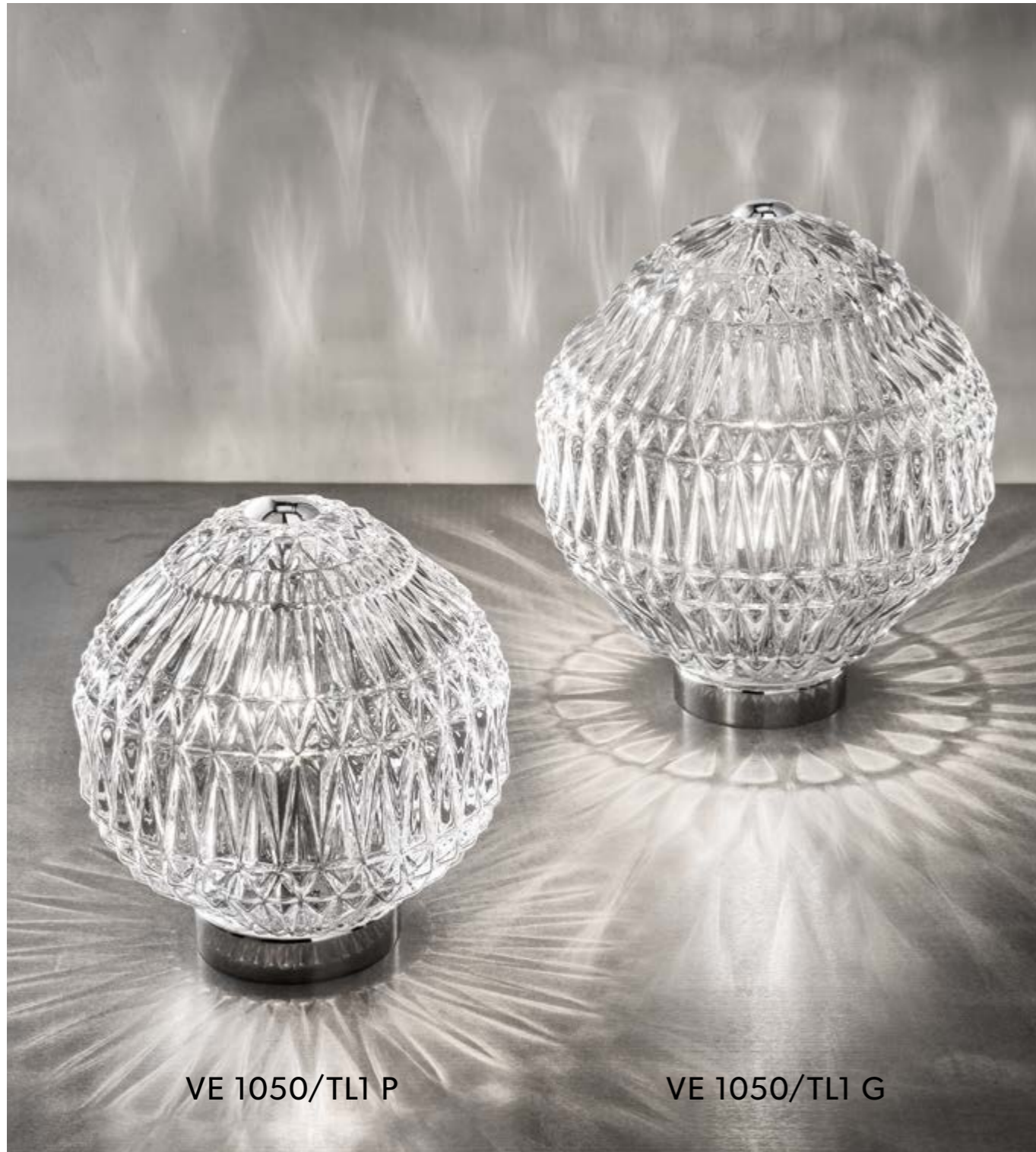

VE 1050/TL1 P

VE 1050/TL1 G



VE 1051/TL1 P

VE 1050/TL1 P * VE 1050/TL1 G * VE 1051/TL1 P * VE 1051/TL1 G *

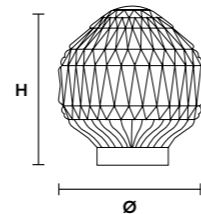
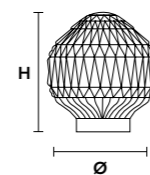
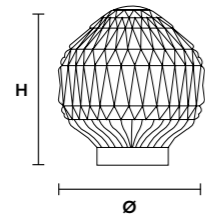
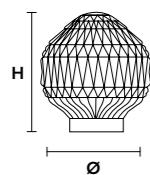

Ø 20 cm / 7.90"
H 22 cm / 8.70"
W 1.8 kg / 3.97 lb

Ø 30 cm / 11.90"
H 26 cm / 10.25"
W 2 kg / 4.40 lb

Ø 20 cm / 7.90"
H 22 cm / 8.70"
W 1.8 kg / 3.97 lb

Ø 30 cm / 11.90"
H 26 cm / 10.25"
W 2 kg / 4.40 lb

WW 1×E14×40 W max(not included)
USA 1×E12×40 W max(not included)

WW 1×E14×40 W max(not included)
USA 1×E12×40 W max(not included)

WW 1×E14×40 W max(not included)
USA 1×E12×40 W max(not included)

WW 1×E14×40 W max(not included)
USA 1×E12×40 W max(not included)



VE 1054/TL1 MOK  **VE 1054/TL1 TRS** 

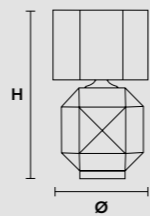
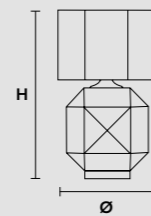

Ø	23 cm / 9.00"	Ø	23 cm / 9.00"
H	37 cm / 14.60"	H	37 cm / 14.60"
W	2.6 kg / 5.73 lb	W	2.6 kg / 5.73 lb
WW	1×E27×60 W max (not included)	WW	1×E27×60 W max (not included)
USA	1×E26×60 W max (not included)	USA	1×E26×60 W max (not included)



VE 1054/TL1 MOK

VE 1054/TL1 TRS



VE 1049/TL1 G G14



VE 1049/TL1 P G04

VE 1049/TL1 G G04

VE 1049/TL1 P G14  

VE 1049/TL1 G G14  

VE 1049/TL1 P G04  

VE 1049/TL1 G G04  

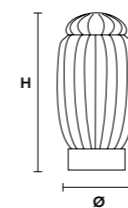

Ø 11 cm / 4.30"
H 23 cm / 9.00"
W 1 kg / 2.20 lb

WW 1×E14×40 W max(not included)
USA 1×E12×40 W max(not included)

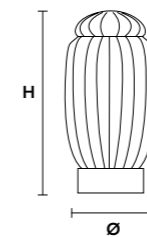

Ø 14 cm / 5.50"
H 30 cm / 11.90"
W 1.5 kg / 3.31 lb

WW 1×E14×40 W max(not included)
USA 1×E12×40 W max(not included)

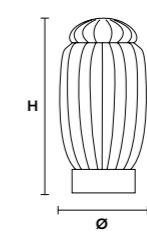

Ø 11 cm / 4.30"
H 23 cm / 9.00"
W 1 kg / 2.20 lb

WW 1×E14×40 W max(not included)
USA 1×E12×40 W max(not included)

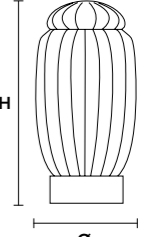

Ø 14 cm / 5.50"
H 30 cm / 11.90"
W 1.5 kg / 3.31 lb

WW 1×E14×40 W max(not included)
USA 1×E12×40 W max(not included)

* ETL only for US market.



VE 1059/TL1 TRS



VE 1023/TL1 G

VE 1023/TL1 P

VE 1059/TL1 TRS * VE 1023/TL1 G VE 1023/TL1 P *

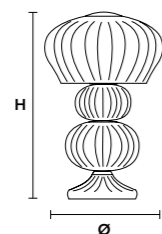

Ø 20 cm / 7.90"
H 30 cm / 11.90"
W 2 kg / 4.41 lb

WW 1×E14×40 W max(not included)
USA 1×E12×40 W max(not included)

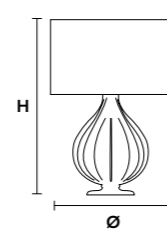

Ø 32 cm / 12.59"
H 58 cm / 22.80"
W 4 kg / 8.82 lb

WW 1×E14×40 W max(not included)
USA 1×E12×40 W max(not included)

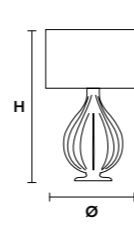

Ø 20 cm / 7.90"
H 37 cm / 14.60"
W 1.5 kg / 3.30 lb

WW 1×E14×40 W max(not included)
USA 1×E12×40 W max(not included)

* ETL only for US market.



VE 1007/TL1



VE 1005/TL1

VE 1007/TL1

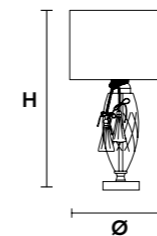

Ø 32 cm / 12.59"
H 58 cm / 22.80"

WW 1×E27×60 W max (not included)
USA 1×E26×60 W max (not included)

VE 1005/TL1

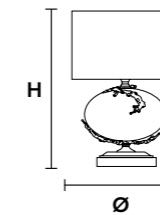

Ø 23 cm / 9.00"
H 34 cm / 14.00"
W 2 kg / 4.40 lb

WW 1×E27×60 W max (not included)
USA 1×E26×60 W max (not included)



VE 1008/TL1

VE 1008/TL1



VE 1010/TL1

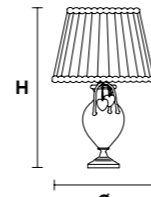
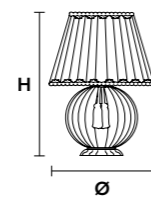

Ø 30 cm / 11.80"
H 41 cm / 16.20

Ø 40 cm / 15.74"
H 65 cm / 25.59"



WW 1×E27×60 W max (not included)
USA 1×E26×60 W max (not included)

WW 1×E27×60 W max (not included)
USA 1×E26×60 W max (not included)



VE 1010/TL1



VE 1022/TL1  

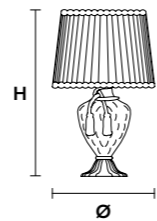

Ø 48 cm / 18.90"
 H 76 cm / 30.00"

WW 1×E27×60 W max (not included)
 USA 1×E26×60 W max (not included)

VE 1022/TL1

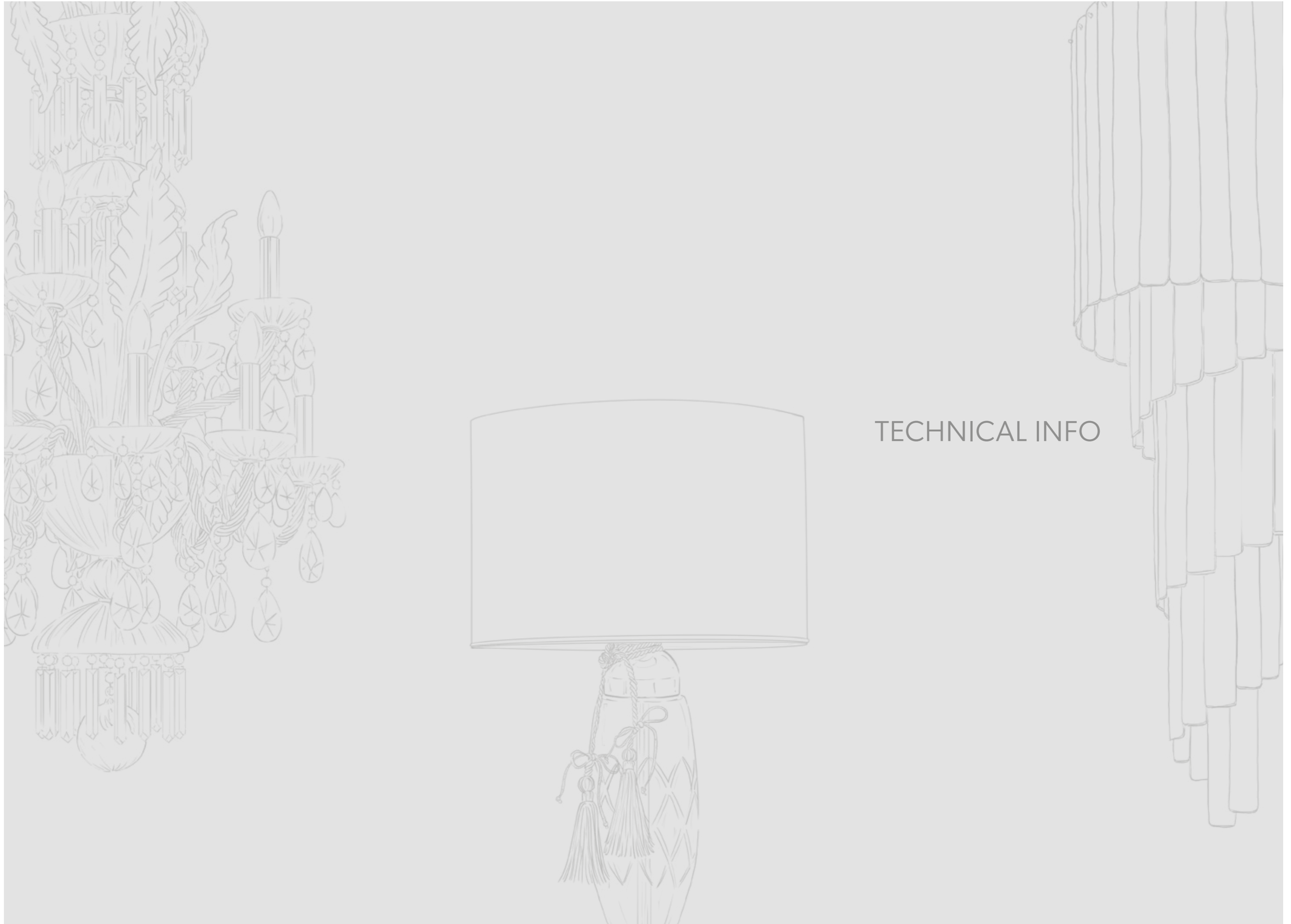

TECHNICAL INFO

FINITURE / FINISHING

Bagno galvanico / Galvanic Bath



G07 Nickel spazzolato
Brushed nickel



G06 Cromo opaco
Matt chrome

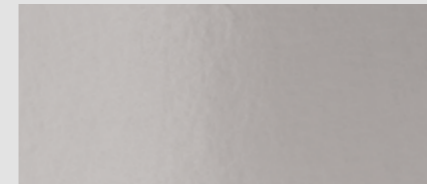

G04 Cromo lucido
Shiny chrome



G21 Cromo anticato
Antiqued chrome



G14 Ottone brunito
Burnished brass



G01 Brunito
Burnished



G05 Oro opaco
Matt gold



G03 Oro lucido
Shiny gold



G12 Oro spazzolato
Brushed gold



G20 Oro anticato
Antiqued gold



G18 Ottone spazzolato
Brushed brass

Verniciati / Painted



V71 Nickel opaco verniciato
Painted matt nickel



V93 Oro verniciato
Painted gold

Verificare la disponibilità di ciascuna finitura per specifici articoli / Availability of each finish to be confirmed for specific items.

Indice/Index

COD.	Ø/L-SP	H	PAG.
VE 871/32	Ø 110 cm	H 270 cm	11
VE 871/64	Ø 140 cm	H 500 cm	10
VE 871/A3	L 50 - SP 28 cm	H 54 cm	9
VE 871/A5	L 50 - SP 28 cm	H 54 cm	8
VE 871/A12	L 75 - SP 30 cm	H 140 cm	9
VE 873/24	Ø 145 cm	H 175 cm	5
VE 873/A5	L 53 - SP 30 cm	H 50 cm	7
VE 874/6	Ø 77 cm	H 63 cm	16
VE 874/8	Ø 88 cm	H 76 cm	17
VE 874/5+5	Ø 88 cm	H 112 cm	14
VE 874/12	Ø 103 cm	H 80 cm	15
VE 874/16+8	Ø 95 cm	H 110cm	13
VE 874/A2	L 35 - SP 22 cm	H 26 cm	19
VE 874/A3	L 44 - SP 26 cm	H 26 cm	18
VE 875/12	Ø 120 cm	H 120 cm	20
VE 875/16	Ø 145 cm	H 120 cm	21
VE 875/A3	L 48 - SP 35 cm	H 50 cm	23
VE 886/12	Ø 70 cm	H 130 cm	25
VE 886/A3	L 48 - SP 28 cm	H 40 cm	27
VE 886/A5	L 50 - SP 30 cm	H 60 cm	26
VE 886/PL3	Ø 45 cm	H 40 cm	29
VE 1005/TL1	Ø 23 cm	H 34 cm	73
VE 1007/TL1	Ø 32 cm	H 58 cm	72
VE 1008/TL1	Ø 30 cm	H 41 cm	74
VE 1010/TL1	Ø 40 cm	H 65 cm	75
VE 1022/TL1	Ø 48 cm	H 76 cm	77
VE 1023/TL1 G	Ø 32 cm	H 58 cm	71
VE 1023/TL1 P	Ø 20 cm	H 37 cm	71
VE 1049/TL1 G G04 - G G14	Ø 14 cm	H 30 cm	68-69
VE 1049/TL1 P G04 - P G14	Ø 11 cm	H 23 cm	69
VE 1050/TL1 G	Ø 30 cm	H 26 cm	64
VE 1050/TL1 P	Ø 20 cm	H 22 cm	64
VE 1051/TL1 G	Ø 30 cm	H 26 cm	64
VE 1051/TL1 P	Ø 20 cm	H 22 cm	65
VE 1052/TL1 G	Ø 32 cm	H 50 cm	63
VE 1052/TL1 P	Ø 25 cm	H 38 cm	62

COD.	Ø/L-SP	H	PAG.
VE 1053/TL1 G	Ø 32 cm	H 50 cm	62
VE 1053/TL1 P	Ø 25 cm	H 38 cm	63
VE 1054/TL1 MOK - TRS	Ø 23 cm	H 37 cm	67
VE 1055/TL1	Ø 18 cm	H 35 cm	61
VE 1056/TL1 BLU - YEL	Ø 18 cm	H 35 cm	60
VE 1057/TL1	Ø 29 cm	H 49 cm	59
VE 1058/TL1	Ø 29 cm	H 49 cm	59
VE 1059/TL1 TRS	Ø 20 cm	H 30 cm	70
VE 1110/A1+1	L 45 - SP 23 cm	H 60 cm	49
VE 1110/PL5+3+2	Ø 100 cm	H 60 cm	50
VE 1110/PL12+2	Ø 140 cm	H 85 cm	51
VE 1112/A1+1	L 40 - SP 20 cm	H 55 cm	53
VE 1112/PL6+3+3	Ø 110 cm	H 70 cm	52
VE 1114/PL3 AMB - TR	Ø 45 cm	H 12 cm	54
VE 1115/PL5 AMB - TR	Ø 65 cm	H 15 cm	54-55
VE 1116/A2 AMB - TR	L 28 - SP 15 cm	H 38 cm	56-57
VE 1120/28	Ø 170 cm	H 150 cm	41
VE 1120/A2	L 38 - SP 20 cm	H 40 cm	43
VE 1120/PL12	L 80 - SP 80 cm	H 80 cm	36
VE 1120/PL14	L 100 - SP 100 cm	H 80 cm	36
VE 1120/PL16	L 120 - SP 120 cm	H 80 cm	37
VE 1144/S20	Ø 50 cm	H 230 cm	35
VE 1144/S30	Ø 80 cm	H 360 cm	34
VE 1144/S40	Ø 100 cm	H 450 cm	34
VE 1144/S52	Ø 120 cm	H 500 cm	34
VE 1145/S6	Ø 52 cm	H 50 cm	46
VE 1145/S14	Ø 80 cm	H 75 cm	47
VE 1145/S20	Ø 100 cm	H 110 cm	46
VE 1145/S8 OV	L 85 - SP 52 cm	H 50 cm	44
VE 1145/S14 OV	L 120 - SP 52 cm	H 50 cm	45
VE 1145/S20 OV	L 155 - SP 52 cm	H 50 cm	44
VE 1146/A4	L 26 - SP 14 cm	H 70 cm	32
VE 1146/PL14	Ø 70 cm	H 140 cm	31
VE 1147/PL16	L 120 - SP 60 cm	H 50 cm	39
VE 1149/S7	Ø 40 cm	H 90 cm	33
VE 1149/S16	Ø 50 cm	H 160 cm	32

CE

Attesta la conformità del prodotto alle disposizioni delle Direttive comunitarie.

It certifies the conformity of the products to the European Community provisions.

Il atteste la conformité du produit aux dispositions des directives communitaires.

Konformität des Produktes mit den Richtlinien der europäischen Gemeinschaft.

НАСТОЯЩИМ ПОДТВЕРЖДАЕТСЯ СООТВЕТСТВИЕ ПРОДУКЦИИ ПОЛОЖЕНИЯМ ДИРЕКТИВ ЕС.

Certifica la conformidad del producto según las disposiciones de las directivas comunitarias.

CE标记是指产品的制造商证明该产品符合适用的EC指令的所有基本要求。

يُشهد بمطابقة المنتج لأحكام توجيهات المجتمع الأوروبي.



Il logo "ETL" si riferisce agli articoli che possono essere modificati con componenti certificati ETL. L'elenco degli articoli ETL si riferisce a prodotti testati e valutati in base agli standard di sicurezza del mercato statunitense. Per il mercato USA fare riferimento al listino dedicato.

"ETL" logos refers to articles which can be modified with ETL-compliance components. The "ETL" listing articles stands for tested and evaluated product to recognised US safety standards. For the US market, refer to the relevant price list.

"ETL" logo se réfère aux articles qui peuvent être modifiés par des composants certifiés ETL. la liste des articles ETL se réfère à des produits testés et évalués selon les normes de sécurité du marché américain. Pour le marché américain se référer à la liste des prix.

Das "ETL"-Logo bezieht sich auf Artikel, die mit ETL-zertifizierten Komponenten modifiziert werden können. Die Liste der ETL-Artikel bezieht sich auf Produkte, die nach den Sicherheitsstandards des US-Marktes getestet und bewertet wurden. Für den US-Markt beachten Sie bitte die entsprechende Preisliste.

ЛОГОТИП «ETL» ОТНОСИТСЯ К ЭЛЕМЕНТАМ, КОТОРЫЕ МОГУТ БЫТЬ МОДИФИЦИРОВАНЫ С ПОМОЩЬЮ СЕРТИФИЦИРОВАННЫХ ETL КОМПОНЕНТОВ. СПИСОК ЭЛЕМЕНТОВ ETL ОТНОСИТСЯ К ПРОДУКЦИИ, ПРОТЕСТИРОВАННОЙ И ОЦЕНЕННОЙ В СООТВЕТСТВИИ С ПРИЗНАННЫМИ СТАНДАРТАМИ БЕЗОПАСНОСТИ США. ДЛЯ ПОТРЕБИТЕЛЕЙ НАХОДЯЩИХСЯ В США СМ. СООТВЕТСТВУЮЩИЙ ПРАЙС-ЛИСТ.

El logo "ETL" indica los artículos, que pueden modificarse con componentes certificados ETL. La lista de los artículos ETL se refiere a los productos sometidos a prueba y evaluados en función de los estándares de seguridad del mercado estadounidense. Consultar la lista de precios específica para el mercado de los Estados Unidos.

"ETL" 徽标是指可以使用ETL认证的组件进行修改的项目。 ETL项目列表是指根据美国市场的安全标准进行测试和评估的产品。 对于美国市场, 请参考美国市场价格表。

يشير شعار «ETL» إلى المنتجات التي يمكن تعديلها باستخدام مكونات مُعتمدة من ETL. تشير قائمة منتجات ETL إلى المنتجات التي تم اختبارها وتقييمها وفقًا لمعايير السلامة في السوق الأمريكي. بالنسبة لسوق الولايات المتحدة الأمريكية، يُرجى الرجوع إلى قائمة الأسعار المُخصصة.

Im

Flusso luminoso nominale. L'indicazione si riferisce al valore in assenza di rifrazione, come dichiarato dal produttore del componente.

Nominal luminous flux. It refers to the value without any refraction, as declared by the component manufacturer.

L'unité SI de flux lumineux. L'indication correspond à la valeur en l'absence de réfraction, comme indiqué par le fabricant du composant.

Die Maßeinheit für den Lichtstrom. Die Angabe bezieht sich auf den Wert in der Abwesenheit von Brechung, wie vom Hersteller der Komponente angegeben.

НОМИНАЛЬНЫЙ СВЕТОВОЙ ПОТОК. УКАЗАНИЕ ОТНОСИТСЯ К ЗНАЧЕНИЮ В ОТСУТСТВИЕ РЕФРАКЦИИ, КАК ЗАЯВЛЕНО ПРОИЗВОДИТЕЛЕМ КОМПОНЕНТОВ.

Flujo luminoso nominal. La indicación se refiere al valor sin refracción, como declarado por el fabricante del componente.

标称光通量。指示是指组件制造商声明的没有折射的值。

التدفق الضوئي الاسمي. يشير المؤشر إلى القيمة في حالة عدم وجود انكسار للضوء، كما هو مُعلن من قبل الشركة المصنعة للعنصر.

MASIERO

Masiero si riserva il diritto di apportare ai propri articoli, senza nessun preavviso, qualsiasi modifica ritenesse opportuna.

Masiero reserves the right to introduce any changes to its own products, without notice in advance.

Masiero se réserve le droit d'apporter une quelconque modification à les modèles sans préavis.

Masiero behält sich das Recht vor Änderungen vorzunehmen, ohne sofortige Benachrichtigung.

КОМПАНИЯ MASIERO ОСТАВЛЯЕТ ЗА СОБОЙ ПРАВО БЕЗ ПРЕДВАРИТЕЛЬНОГО УВЕДОМЛЕНИЯ, ЕСЛИ ЭТО БУДЕТ СОЧТЕНО ЦЕЛЕСООБРАЗНЫМ, ВНОСИТЬ В СОБСТВЕННЫЕ МОДЕЛИ ЛЮБЫЕ ИЗМЕНЕНИЯ.

Masiero se reserva el derecho de aportar modificaciones consideradas oportunas a sus artículos sin preaviso.

Masiero 保留对其认为适当的任何更改的权利, 恕不另行通知。

تحتفظ شركة مازيرو "Masiero" بالحق في إجراء أي تعديلات تراها مناسبة على منتجاتها، دون إشعار مسبق.

Masiero srl

via Peschiere, 53
31032 Casale sul Sile
Treviso, Italy
T +39 0422 7861
F +39 0422 786250

info@masierogroup.com
masierogroup.com

Design by Masiero
Photo, Studio Pointer
Print Italy, April 2021
by Grafica Antiga

